

Report of Investigations 8507

Structure Response and Damage Produced by Ground Vibration From Surface Mine Blasting

By D. E. Siskind, M. S. Stagg, J. W. Kopp,
and C. H. Dowding



UNITED STATES DEPARTMENT OF THE INTERIOR
Cecil D. Andrus, Secretary
BUREAU OF MINES
Lindsay D. Norman, Director

US Department of Interior
Office of Surface Mining
Reclamation and Enforcement



Kenneth K. Eltschlager
Mining/Blasting Engineer
3 Parkway Center
Pittsburgh, PA 15220

Phone 412.937.2169
Fax 412.937.3012
Keltschl@osmre.gov

This publication has been cataloged as follows:

United States. Bureau of Mines

Structure response and damage produced by ground vibration from surface mine blasting.

(Report of investigations • Bureau of Mines ; 8507)

Bibliography: p. 69-70.

1. Blast effect. 2. Buildings—Vibration. 3. Soils—Vibration. 4. Strip mining—Environmental aspects. I. Siskind, D. E. II. Title. III. Series: United States. Bureau of Mines. Report of investigations ; 8507.

TN23.U43 [TA654.7] 622s [690'.21] 80-607825

CONTENTS

	<i>Page</i>		<i>Page</i>
Abstract	1	Failure characteristics of building materials	43
Introduction	3	Gypsum wallboard failure	43
Acknowledgments	4	Masonry and concrete failure	45
Ground vibration characteristics	5	Fatigue	45
Time and frequency properties of mining blasts ..	5	Safe vibration levels for residential structures	47
Other vibration sources	6	Previous damage studies	47
Generation and propagation	9	New Bureau of Mines damage studies	51
Blast design and ground vibration generation ...	9	Summary damage analysis	52
Vibration comparisons: Mine and quarry blasts ..	14	Mean and variance analysis	52
Response of residential structures	18	Probability analysis	55
Response spectrum analysis techniques	18	Safe blasting levels	58
Direct measurement of structure responses	21	Response spectra analysis of damage cases	60
Test structures	21	Existing standards for vibrations	61
Instrumenting for response	30	Human response	62
Natural frequency and damping	30	Conclusions	68
Production blasting	31	References	69
Velocity exposure levels	31	Appendix A.—Existing vibration standards and cri-	
Structure responses from blasting	32	teria to prevent damage	71
Amplification factors	33	Appendix B.—Alternative blasting level criteria	73
Airblast response	41		
Structure responses from everyday activities ...	41		

ILLUSTRATIONS

	<i>Page</i>
1. Occupied residences near operating surface mine	2
2. Predominant frequencies of vibrations from coal mine, quarry, and construction blasting	6
3. Coal mine blast time histories and spectra measured at 2,287 ft	7
4. Quarry blast time histories and spectra measured at 540 ft	7
5. Construction blast time histories and spectra measured at 75 ft	8
6. Ground vibrations from a single coal mine	15
7. Radial ground vibration propagations from surface coal mines	15
8. Vertical ground vibration propagations from surface coal mines	15
9. Transverse ground vibration propagations from surface coal mines	15
10. Summary of ground vibrations from all surface coal mines	16
11. Zones of mean propagation regressions for two major types of blasting	17
12. Ground vibration propagation for three types of blasting as found by Lucole	17
13. Single degree of freedom model and types of structures response	18
14. Response spectra for mining and construction shots, after Corser	19
15. Test structure 19, near a coal mine	21
16. Test structure 20, near a coal mine	24
17. Test structure 21, near a coal mine	24
18. Test structure 22, near a quarry	24
19. Test structure 23, near a quarry	25
20. Test structure 26, near a coal mine	25
21. Test structure 27, near a coal mine	25
22. Test structure 28, near a coal mine	26
23. Test structure 29, near a coal mine	26
24. Test structure 30, near a coal mine	27
25. Test structure 31, near a coal mine	27
26. Test structure 49, near a coal mine	27
27. Test structure 51, near a coal mine	28
28. Test structure 61, near a coal mine	28
29. Vibration gages mounted in corners and on walls for measuring structure response in structure 51	29
30. Ground vibration, structure vibration, and airblast time histories from a coal mine highwall blast	30
31. Residential structure natural frequencies	31
32. Residential structure damping values	32
33. Corner and midwall responses for a single structure	34
34. Structure responses (corners) from peak horizontal ground vibrations, summary	34
35. Structure responses (corners) from peak horizontal ground vibrations with measured values	35
36. Structure responses (corners) from peak vertical ground vibrations	35

ILLUSTRATIONS—Continued

	<i>Page</i>
37. Midwall responses from peak horizontal ground vibrations	36
38. Amplification factors for blast-produced structure vibration (corners) of a single 1-story and a single 2-story house	37
39. Amplification factors for blast-produced structure vibration (corners), all homes	37
40. Amplification factors for blast-produced midwall vibration, all homes	38
41. Ground vibration and airblast that produce equivalent amounts of structure response, in frame residential structures of up to 2 stories	39
42. Test residential fatigue structure near surface coal mine	40
43. Plan of main floor of test fatigue structure shown in figure 42	40
44. Failure strains for residential construction materials from a variety of sources (tables 7 and 8)	44
45. Fatigue test model on biaxial vibrating table	46
46. Damage observations, new Bureau of Mines data from production blasting in surface mines	51
47. Nondamage observations, new Bureau of Mines data from surface mine blasting	51
48. Displacement versus frequency for low-frequency blasts in glacial till, set 2 mean and variance analysis	53
49. Displacement versus frequency for low-frequency blasts and shaker tests, set 4 mean and variance analysis ..	53
50. Displacement versus frequency for low-frequency blasts, shaker tests, and masonry damage, set 5 mean and variance analysis	53
51. Displacement versus frequency for high-frequency blasts, set 6 mean and variance analysis	54
52. Displacement versus frequency summary, set 7 mean and variance analysis	54
53. Velocity versus frequency for the various damage data sets, mean and variance analysis	55
54. Velocity versus frequency summary, set 7 mean and variance analysis	56
55. Probability damage analysis for low-frequency blasts in glacial till, set 2	57
56. Probability damage analysis for low-frequency blasts and shaker tests, set 4	57
57. Probability damage analysis for low-frequency blasts, shaker tests, and masonry damage, set 5	57
58. Probability damage analysis for high-frequency blasts, set 6	57
59. Probability damage analysis summary, set 7	58
60. Human tolerance standards for rms vibrations exceeding 1-minute-duration ISO 2631	63
61. Human response to steady-state and transient vibrations	64
62. Human response to transient vibration velocities of various durations	64
63. Human response to transient vibration accelerations of various durations	64
64. Human response to vibrations of damped concrete floors, after Murray	65
65. Human response to concrete floor vibrations of various durations	66
66. Human response to vibrations of various durations, summary	66
67. Reactions of persons subjected to blasting vibration in their homes	67
B-1. Safe levels of blasting vibration for houses using a combination of velocity and displacement	73

TABLES

	<i>Page</i>
1. Production blasts and ground vibration measurements	10
2. Equations and statistics for ground vibration propagation	14
3. Test structures and measured dynamic properties	22
4. Equations and statistics for peak structure responses from ground vibrations	33
5. Strains in fatigue test structure from blasting and human activity	41
6. Structure vibrations in test fatigue structure from blasting and human activity	42
7. Failure characteristics of plaster and gypsum wallboard	43
8. Failure of masonry and concrete	45
9. Studies of damage to residences from blasting vibrations	48
10. Damage classification	49
11. Data sets used for damage analyses	52
12. Summary of damage statistics by data sets	59
13. Safe levels of blasting for residential type structures	59
14. Studies of human response to vibrations	63
15. Subjective responses of humans to vibrations of various durations	67
A-1. German vibration standards, DIN 4150	71
A-2. Damage levels from blasting, after Langefors and Kihlstrom	71
A-3. Limiting safe vibration values of pseudo vector sum peak particle velocities, after Esteves	71
A-4. Limiting safe vibration values, after Ashley	72
A-5. Vibration limits for laboratory instruments, after Whiffin and Leonard	72

STRUCTURE RESPONSE AND DAMAGE PRODUCED BY GROUND VIBRATION FROM SURFACE MINE BLASTING

by

D. E. Siskind¹, M.S. Stagg², J. W. Kopp³, and C. H. Dowding⁴

ABSTRACT

The Bureau of Mines studied blast-produced ground vibration from surface mining to assess its damage and annoyance potential, and to determine safe levels and appropriate measurement techniques. Direct measurements were made of ground-vibration-produced structure responses and damage in 76 homes for 219 production blasts. These results were combined with damage data from nine other blasting studies, including the three analyzed previously for Bureau of Mines Bulletin 656.

SAFE ~~Safe~~ levels of ground vibration from blasting range from 0.5 to 2.0 in/sec peak particle velocity for residential-type structures. The damage threshold values are functions of the frequencies of the vibration transmitted into the residences and the types of construction. Particularly serious are the low-frequency vibrations that exist in soft foundation materials and/or result from long blast-to-residence distances. These vibrations produce not only structure resonances (4 to 12 Hz for whole structures and 10 to 25 Hz for midwalls) but also excessive levels of displacement and strain.

Threshold damage was defined as the occurrence of cosmetic damage; that is, the most superficial interior cracking of the type that develops in all homes independent of blasting. Homes with plastered interior walls are more susceptible to blast-produced cracking than modern gypsum wallboard; the latter are adequately protected by a minimum particle velocity of approximately 0.75 in/sec for frequencies below 40 Hz.

Structure response amplification factors were measured; typical values were 1.5 for structures as a whole (racking) and 4 for midwalls, at their respective resonance frequencies. For blast vibrations above 40 Hz, all amplification factors for frame residential structures were less than unity.

The human response and annoyance problem from ground vibration is aggravated by wall rattling, secondary noises, and the presence of airblast. Approximately 5 to 10 pct of the neighbors will judge peak particle velocity levels of 0.5 to 0.75 in/sec as "less than acceptable" (i.e., unacceptable) based on direct reactions to the vibration. Even lower levels cause psychological response problems, and thus social, economic, and public relations factors become critical for continued blasting.

¹ Geophysicist, Twin Cities Research Center, Bureau of Mines, Twin Cities, Minn.

² Civil engineer, Twin Cities Research Center, Bureau of Mines, Twin Cities, Minn.

³ Mining engineer, Twin Cities Research Center, Bureau of Mines, Twin Cities, Minn.

⁴ Civil engineer; Professor of Civil Engineering, Northwestern University, Evanston, Ill.

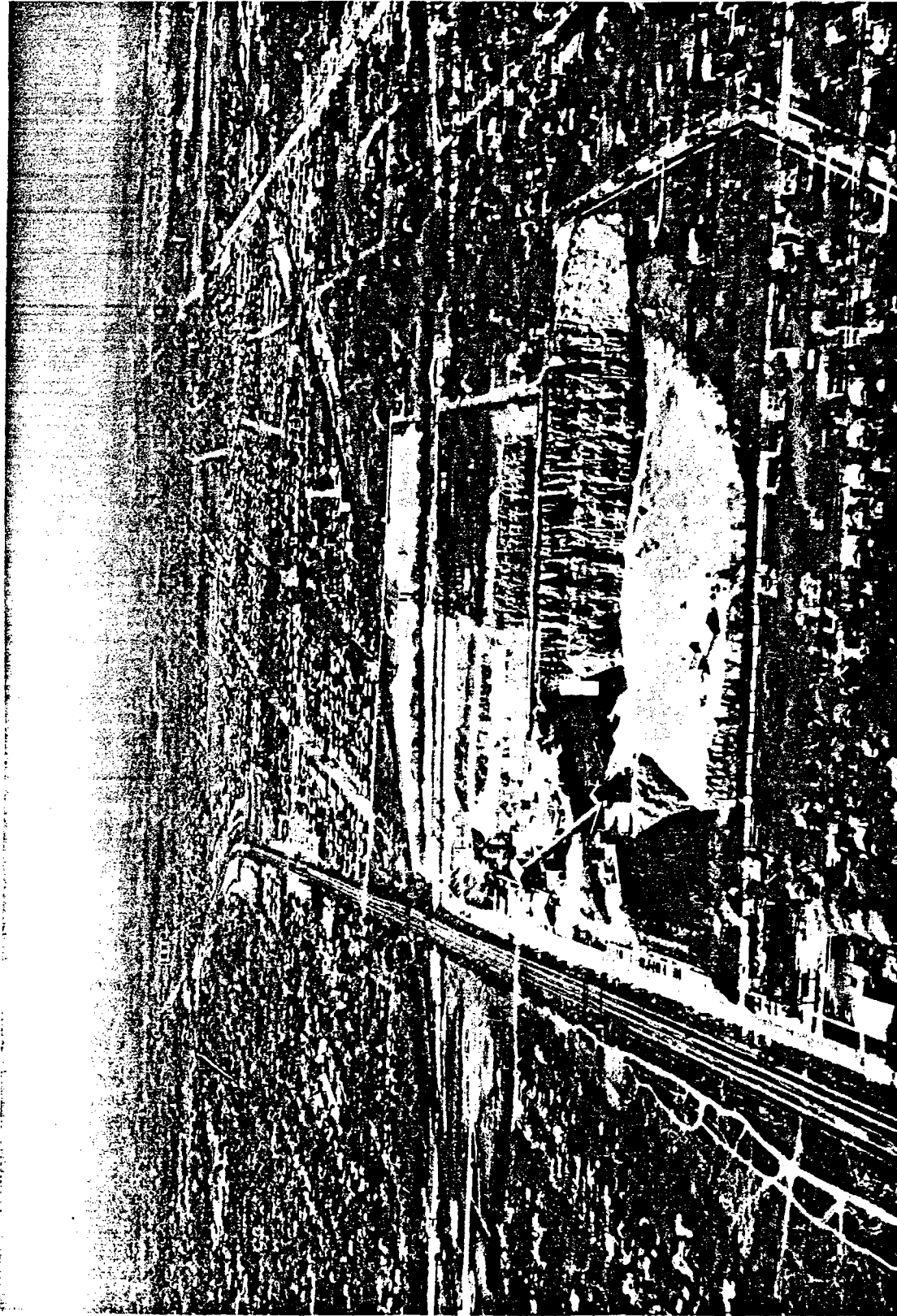

Figure 1.—Occupied residences near operating surface mine.

INTRODUCTION

Ground vibrations from blasting have been a continual problem for the mining industry, the public living near the mining operations, and the regulatory agencies responsible for setting environmental standards. Since 1930, the Bureau of Mines has studied various aspects of ground vibration, airblast, and instrumentation, culminating in Bulletin 656 in 1971(37)⁵.

In that publication, Nicholls extensively reviewed blast design effects on the generation of vibrations, ground vibration and airblast propagation, and seismic instrumentation. Bulletin 656 established the use of peak particle velocity in place of displacement, a minimum delay interval of 9 msec for scaled distance calculations, and a safe scaled distance design parameter of 50 ft/lb^{1/2} for quarry blasting in the absence of vibration monitoring. The authors also included a damage summary analysis originally published in 1962 by Duvall and Fogelson as Bureau of Mines Report of Investigations 5968 (14). New data available since the 1962 report were described in Bulletin 656, but a new analysis to include these data was not performed.

Recommended was the use of peak particle velocity to assess the damage potential of the ground vibrations, and 2.0 in/sec as an overall safe level for residential structures. These recommendations have been widely adopted by the mining and construction industry and incorporated into numerous State and local ordinances that regulate blasting activity. Soon after publication of the 2.0-in/sec safe level criterion, it became apparent that it was not practical to blast at this high vibration level. Many mining operations with nearby neighbors were designing their blasts to keep velocities as low as 0.40 in/sec. Severe house rattling caused fear of property damage below the 2.0-in/sec level, and many homeowners were attributing all cracks to the blast vibrations.

Pennsylvania was the first State to adopt the 2.0-in/sec peak particle velocity criterion as a safe standard in 1957. However, in 1974 it was forced to adopt stricter controls because of citizen pressure and lawsuits involving both annoyance and alleged damage to residences. There existed no technologically based and supportable criteria for mine, quarry, and construction blasting other than the 2.0-in/sec criteria from Bulletin 656 and RI 5968. The general growth of mining, the proximity of mining and quarrying to their residential neighbors, and greater environmental awareness have all required reexamination of blasting regulations and justified further research.

In 1974 the Bureau of Mines began to reanalyze the blast damage problem, expand the Duvall and Fogelson 1962 study, and overcome its more serious shortcomings through the following efforts:

1. Direct measurements were made of structural response, and damage was observed in residences from actual surface-mine production blasting.
2. Damage data from six additional studies, not available in 1962, were combined with three studies analyzed by Duvall and Fogelson, plus the new Bureau of Mines measurements.
3. Probabilistic analysis techniques were used on various sets of data, as well as the conventional statistical derivation of mean square fit and standard deviation for the various damage thresholds.
4. Particular emphasis was placed on the frequency dependence of structure response and damage, recognizing that the response characteristics and frequency content of the vibrations are critical to response levels and damage probabilities.
5. An analysis was made of various studies of human tolerance to vibrations, although most data are from steady-state rather than impulsive sources.

Italic
⁵ Underlined numbers in parentheses refer to items in the list of references preceding the appendixes.

An understanding of how houses respond to ground vibration and the vibration characteristics most closely related to this response will enable operators to design blasts to minimize adverse effects. The mining industry needs realistic design levels and also practical techniques to attain these levels. At the same time, environmental control agencies responsible for blasting and explosives need reasonable, appropriate, and technologically established and supportable criteria on which to base their regulations. Finally, neighbors around the mining operations and other blasting, as shown in figure 1, require protection of their property and health so that they do not bear an unreasonable personal cost.

This report summarizes the state of knowledge on damage to residences from surface mine, quarry, and construction blasting. Included are discussions of applicable data on fatigue and human response, although work is continuing in these areas. An analysis was also made on vibration production from mining blasts. The generation and propagation data in Bulletin 656 are for smaller quarry blasts, which are also typically characterized by thin overburden layers.

The damage criteria presented herein were developed to quantify the response of and damage to residential-type structures from small to intermediate-sized blasts as used in mining, quarrying, construction, and excavation. Application of these criteria by regulatory agencies will require an analysis of social and economic costs and benefits for the coexistence of blasting and an environmentally conscious society.

ACKNOWLEDGMENTS

The authors acknowledge the generous assistance of many regulatory agencies, engineering consultants, powder companies, homeowners, and mine and quarry operators. Special thanks are due to the Pennsylvania Department of Environmental Resources for demonstrating the need for this ground vibration research. Much of the fieldwork and data reduction was done by Virgil J. Stachura, Alvin J. Engler, Steven J. Sampson, Michael P. Sethna, Bryan W. Huber, Eric Porcher, and John P. Podolinski. Valuable technical support was provided by G. Robert Vandenbos for all stages of the blasting research.

GROUND VIBRATION CHARACTERISTICS

Ground vibrations from blasting are an undesirable side product of the use of explosives to fragment rock for mining, quarrying, excavation, and construction. This ground vibration or seismic energy is usually described as a time-varying displacement, velocity, or acceleration of a particular point (particle) in the ground. It can also be measured as various integrated (averaged) energy levels. Three mutually orthogonal time-synchronized components are required to characterize the motion fully. Alternatively, the three components can be combined into a true vector sum for any instant in time or a pseudo vector sum derived from vector addition of the maximums of each component, independent of time (50).

The descriptors for motion are related by integration and differentiation:

$$V = \frac{d}{dt} D = \int A dt.$$

$$\text{and } A = \frac{d}{dt} V = \frac{d^2}{dt^2} D$$

where D is displacement, V is velocity, and A is acceleration. When the vibrations can be approximated by a sine wave (simple harmonic motion), the relationships above become:

$$\begin{aligned} D &= D_0 \sin(2\pi ft), \\ V &= D_0 (2\pi f) \cos(2\pi ft) = V_0 \cos(2\pi ft), \\ \text{and } A &= -D_0 (2\pi f)^2 \sin(2\pi ft) \\ &= -A_0 \sin(2\pi ft). \end{aligned}$$

where f is frequency, t is time, and, D_0 , V_0 , and A_0 are constants. Peak values correspond to the time when the trigonometric functions equal unity, and the relationships for these peak values then become:

$$\begin{aligned} D_0 &= \frac{V_0}{2\pi f} = \frac{A_0}{(2\pi f)^2} \\ V_0 &= 2\pi f D_0 = \frac{A_0}{2\pi f} \\ \text{and } A_0 &= (2\pi f)^2 D_0 = 2\pi f V_0 \end{aligned}$$

Complex vibrations cannot be approximated by the simple harmonic motion, and either electronic or numeric (computer) integration and

differentiation become necessary for conversions.

Interactions between the vibrations and the propagating media give rise to several types of waves, including direct compressional and shear body waves, refracted body waves, and both horizontally and vertically polarized surface waves. These vibrational waves are of primary importance in studies of the earth's interior and earthquake characteristics, but their individual effects have been totally neglected in blasting seismology. Analysis of damage to structures does not require knowledge of what happens between the source and the receiver or of the type of wave. It requires only the vibrational input to the house at its foundation. Additionally, multiply-delayed shots are sufficiently complex vibration sources to make identification of individual waves difficult, if not impossible, under most conditions.

TIME AND FREQUENCY PROPERTIES OF MINING BLASTS

The amplitude, frequencies, and durations of the ground vibrations change as they propagate, because of (a) interactions with various geologic media and structural interfaces, (b) spreading out the wave-train through dispersion, and/or (c) absorption, which is greater for the higher frequencies. Close to the blast the vibration character is affected by factors of blast design and mine geometry, particularly charge weight per delay, delay interval, and to some extent direction of initiation, burden, and spacing (56). At large distances the factors of blast design become less critical and the transmitting medium of rock and soil overburden dominate the wave characteristics.

Particle velocity amplitudes are approximately maintained as the seismic energy travels from one material into another (i.e., rock to soil), probably from conservation of energy. However, the vibration frequency and consequently the displacement and acceleration amplitudes depend strongly on the propagating media. Thick soil overburden as well as long absolute (as opposed to scaled) distances create long-duration, low-frequency wave trains. This increases the response and damage potential of nearby structures.

Frequencies below 10 Hz produce large ground displacement and high levels of strain, and also couple very efficiently into structures where typical resonant frequencies are 4 to 12 Hz for the corner or racking motions. Racking is whole-structure distortion with characteristic shear stresses and failures. Previous studies described the frequency character of vibration from quarry (37) and coal mine blasts (56), and a recent report by Stagg on instrumentation for ground vibration summarized the frequency characteristics of vibrations from small to moderate-sized blast sources (50). Ground vibration frequencies from three types of blasts are shown in figure 2, all measured at the closest residence where peak particle velocities were within 0.5 to 2.0 in/sec. Although the shot types in figure 2 are labeled coal mine, quarry, and construction, the frequency-determining factors are the shot sizes, distances, and rock competence. The coal mine and quarry blasts were all more than 200 lb/de-

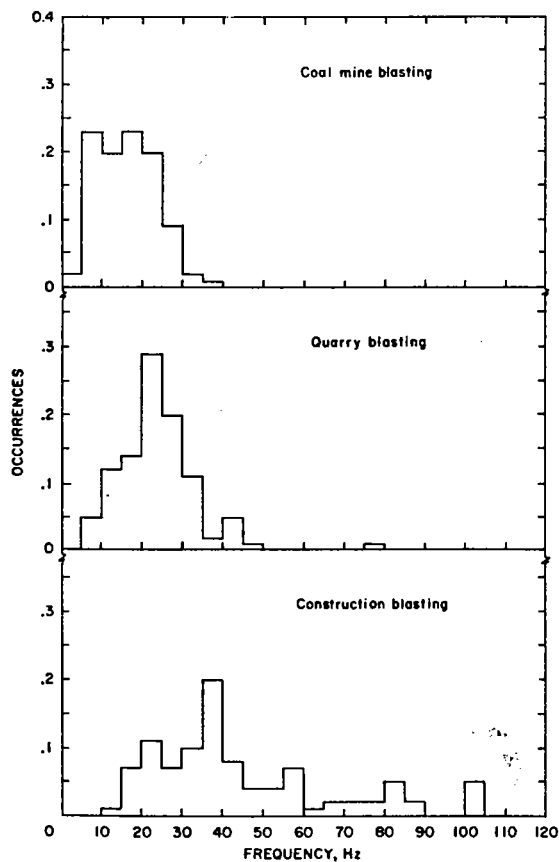

Figure 2.—Predominant frequencies of vibrations from coal mine, quarry, and construction blasting.

lay at distances exceeding 350 ft. The construction (and excavation) shots ranged from 1¼ to 12¾ lb at distances of 30 to 160 ft. Soil overburdens were 0 to 5 ft for construction, under 10 ft for quarries, and generally above 5 to 10 ft for coal mines.

Time histories and Fourier frequency amplitude spectra from three typical blasts measured by a buried three-component transducer are shown in figures 3 to 5 (50). The coal mine shot is characterized by a trailing large-amplitude, low-frequency wave, which is probably a surface wave generated in the overburden layers. Quarry blasts do not usually show this low-frequency tail for one or more of the following reasons: smaller charge weights, smaller shot to instrument distances, and thinner soil overburdens. The combination of large shots, thick soil and sedimentary rock overburdens, relatively good confinement, and long-range propagation make coal mine blast vibrations potentially more serious than quarry and construction blasts because of their low frequencies. By contrast, coal mine highwall blasts are inefficient generators of airblast (46). Hard rock construction and excavation blasts tend to be shorter in duration and contain higher frequency motions than those of either coal mine or quarry.

Frequency characteristics of blast vibrations depend strongly on the geology and blast delay intervals. Except for the short-distance, all-rock case, they are difficult to predict and vary widely. Therefore, it is desirable to obtain complete time histories rather than simple peak values in any sensitive areas. Many examples of continual complaints about severe rattling at levels below 0.5 in/sec are attributable to the low frequencies. Research is continuing on the effects of blast design, face orientation, and near-surface geology on the character of both the ground vibrations and airblast.

OTHER VIBRATION SOURCES

Earthquakes, nuclear blasts, and very large scale, in situ mining shots all produce potentially damaging ground vibrations, as well as do other static and quasistatic vibration sources (traffic, pile driving, sonic booms, etc.). The first Bureau of Mines blast vibration summary in 1942 examined the levels of earthquake vibrations and the corresponding Mercalli intensities for damage, and concluded these did not apply to blasting (51). Earthquakes produce long-duration and very low frequency events.

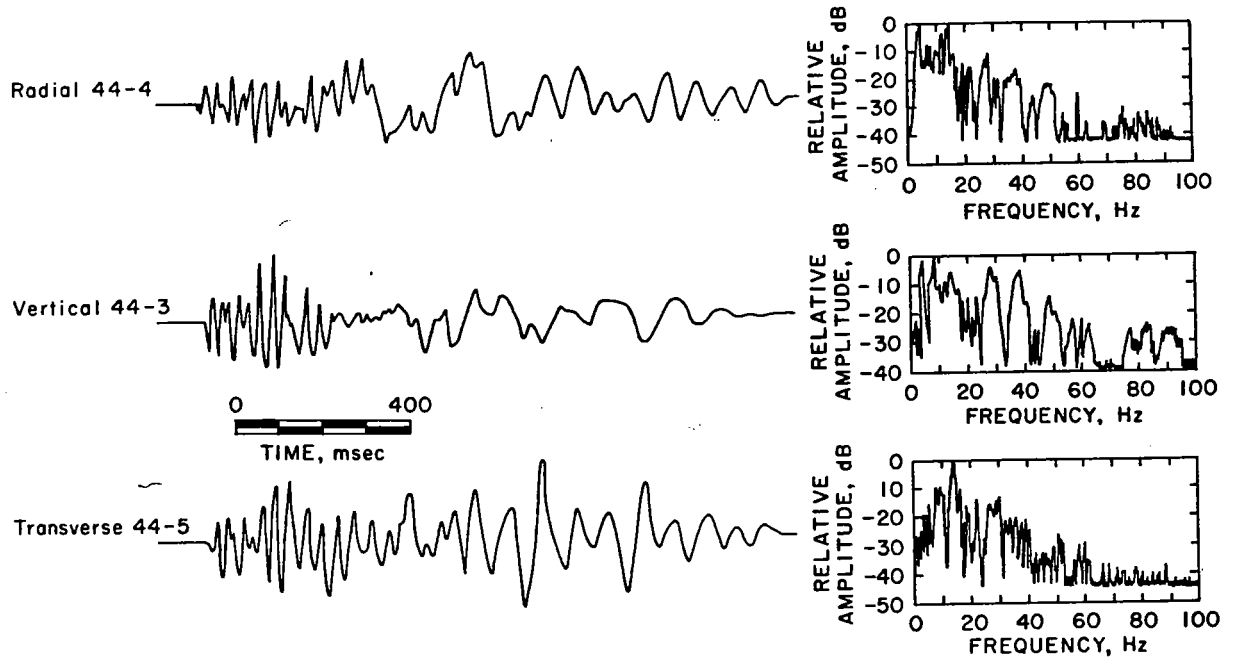

Figure 3.—Coal mine blast time histories and spectra measured at 2,287 ft.

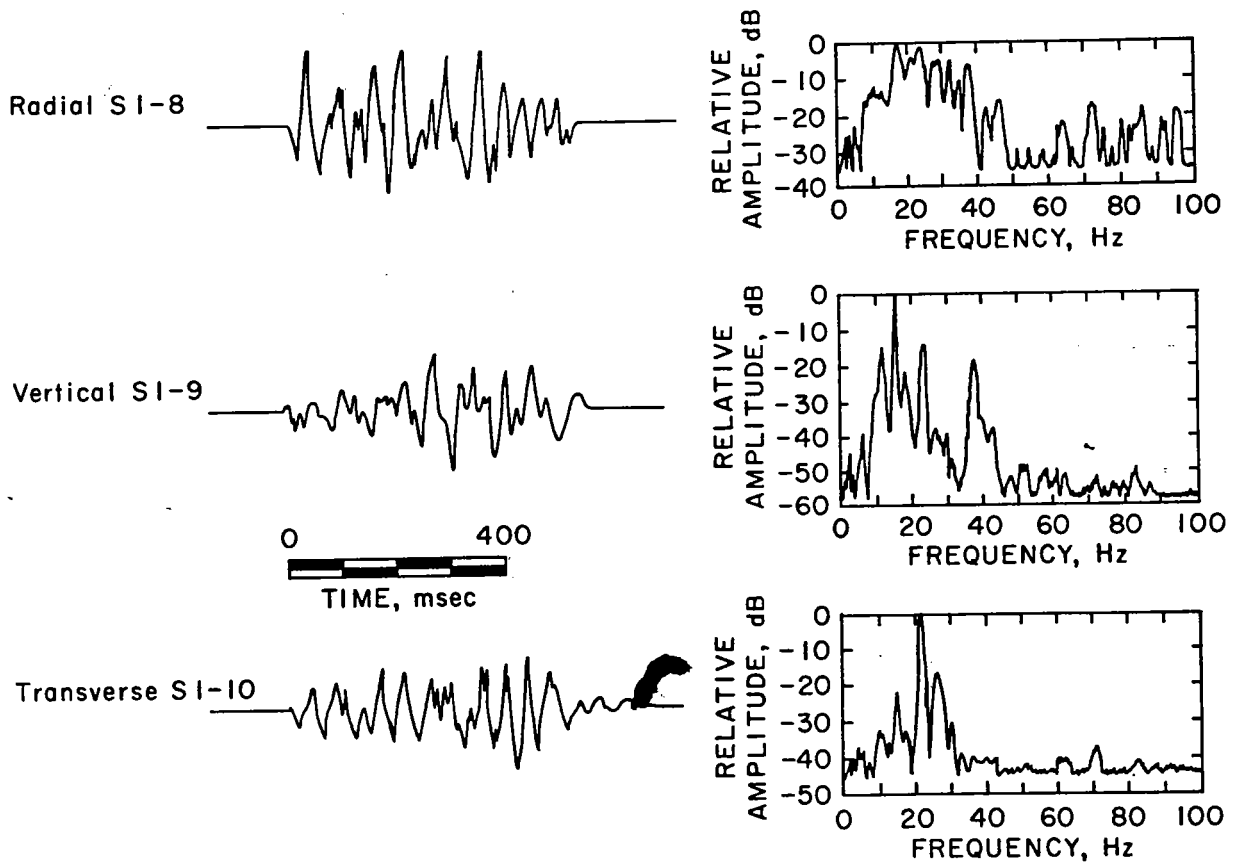

Figure 4.—Quarry blast time histories and spectra measured at 540 ft.

Acceleration levels are typically used by seismologists to quantify damage potential. These may be of moderate and even lower levels than found in blasting; however, their low frequencies produce large particle velocities and enormous displacements. As an example, Richter states that a 0.1 g acceleration at 1 Hz is ordinarily considered damaging in earthquake seismology (41). The corresponding particle velocity and displacement are 6.15 in/sec and 0.98 in, respectively, assuming simple harmonic motion. The same acceleration at 20 Hz would only produce 0.308 in/sec particle velocity and 0.0025 in displacement. Richter also observes that the damage potential of a given vibration is dependent on its duration, with 0.1 g at 1 Hz likely not to produce damage for events of a few seconds, but very serious for earthquake-type events of 25 to 30 sec (41).

A similar case is provided by the Salmon nuclear study and similar large blasts (5, 35, 39, 42-43, 45). These blasts all produced low-frequency and long-duration ground vibrations resulting from their sizes and distances. The

Salmon vibration time history was 90 sec long at the structures (18 to 31 km) that were alleged to have been damaged. These durations are hardly comparable to those in mine, quarry, and construction blasting. Consequently, damage data of this kind cannot justifiably be correlated with the scale of blasting of concern in this analysis. However, the dynamic modeling techniques developed during the extensive research of earthquake and nuclear blast response can be applied to the study of blasting and the mechanisms of structural response.

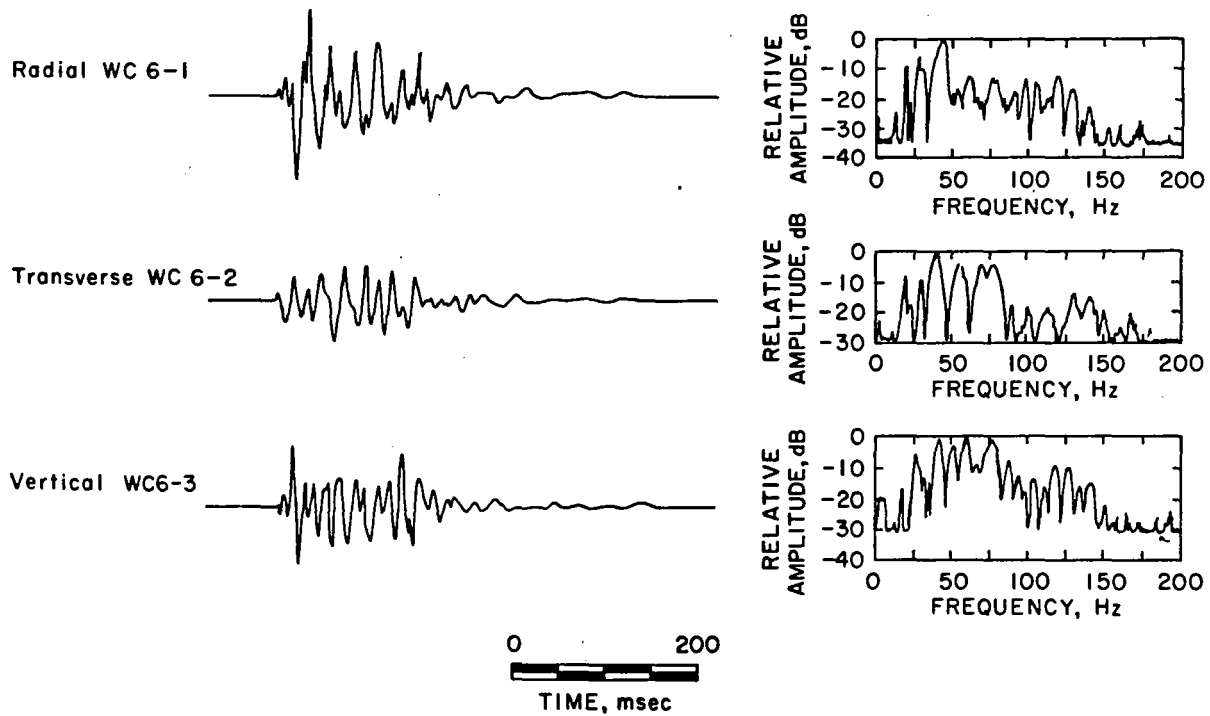

Figure 5.—Construction blast time histories and spectra measured at 75 ft.

GENERATION AND PROPAGATION

Much research has been conducted on ground vibrations. Generation and propagation of ground vibrations have been studied extensively to determine the effects of blast design and geology on vibration amplitudes and frequency character. In Bulletin 656, Nicholls summarized the Bureau's investigation of vibrations produced by blasting in 25 stone quarries, dating back to 1959 (37). The Bureau also conducted a series of studies of vibrations generated in four operating underground metal mines in 1974 (45). A major study was recently completed by Wiss that quantifies the influence of many of the blast design parameters on both ground vibration and airblast generation and propagation in five surface coal mines (56). Lucole also recently published the results of a year of routine monitoring of vibration levels generated by various types of blasting (29).

Prior to the last two studies, no data existed on vibrations generated by blasting in surface coal mines. It has been standard practice to apply the blast design rules developed for the small-hole, hard-rock quarry blasting to surface coal mines. Blast holes in surface coal mines have typical diameters exceeding 6 in, and in large area mines they are typically 9 to 15 in. These diameters are larger than those used in most quarries. The highwall blasts of surface coal mines are heavily confined, since they are used only to loosen the overburden and produce little or no throw. Decking is often used with complex timing systems, combining electronic and pyrotechnic delays. The rock being blasted is highly layered and of lower sonic velocity and strength than that in aggregate and lime quarries. Distances to houses are usually greater than for quarries, which are often in or near urban centers. Soil and incompetent rock overburden beneath structures near coal mines is normally tens of feet thick, far more than at most quarries.

Consequently, coal mine blasting is normally characterized as follows:

1. Relatively large charge weights per delay.
2. Complex delay systems that are optimized for efficient fragmentation but that may produce adverse ground vibration frequencies.
3. Relatively high ground vibration levels close-in from heavy confinement of highwall shots.

4. Relatively rapid falloff of ground vibration levels with distance because of attenuation in weak rock.

5. Ground vibrations having predominantly low frequencies because of thick soil overburdens, strong geologic layering that favors surface waves, and large blast-to-structure distances.

BLAST DESIGN AND GROUND VIBRATION GENERATION

As in studies on quarry blasting, most blast design parameters for surface coal mine blasts have little influence on the generated vibrations. Charge weights per delay were again the most influential parameter. A small decrease in ground vibrations was noted for shallow as opposed to great depths of burial. Also, the location of the receiver relative to both the face and direction of blast initiation influenced the delay intervals at which constructive wave interference was experienced (56).

The Bureau of Mines vibration data are given in table 1. Included are charge weights, distances, ground vibration, and structure vibration levels for the predominantly coal mine blasts. The two horizontal components of motion were aligned with the walls of the nearby structures for analysis of response and did not necessarily correspond to the traditional "radial" and "transverse." The "structure number" of table 1 is for identification, and the "structure type" is the number of stories.

Vibration levels generated from one surface coal mine are shown in figure 6. The maximum horizontal and vertical ground motions were plotted for each blast. Equations and statistics for the various vibration propagations, including Site A (fig. 6), are given in table 2. All particle velocities are in inches per second, distances in feet, and charge weights in pounds. Propagation curves from a variety of surface coal mines are given in figures 7-9. Six of the propagation curves (Nos. 1-2 and 6-9) are from vertical hole blasts studied by Wiss (56). The remaining propagation curve (No. 19) is from a single Bureau of Mines site, where actual radial and transverse values were available.

Table 1.—Production blasts and ground vibration measurements

Shot	Facility	Shot type	Total charge, lb	lb per delay	Sealed distance, ft/lb ^{1/2}	Peak ground vibration, in/sec			Peak structure motion, in/sec						Structure number (table 3)	Structure type	
						H ₁	H ₂	V	Low corner			High corner		Midwall			
									H ₁	H ₂	V	H ₁	H ₂	H ₁			H ₂
1	Coal	Highwall	6,000	500	38.00	1.07	1.07	0.80				0.76	0.49		1.41	27	1
2	Coal	do	7,200	600	33.00	1.38	1.19	.68				.87	.75		1.57	27	1
3	Coal	do	7,800	650	29.00	1.89	1.74	.59				.79	.54		1.55	27	1
4	Coal	do	7,200	1,200	20.00	1.91	1.85	.95				.81	.67		2.19	27	1
5	Coal	do	7,800	1,300	18.10	2.07	2.33	.94				.87	.56	2.37	3.18	27	1
6	Coal	do	7,800	650	24.00	3.73	1.73	.73				.82	.60	2.79	2.83	27	1
7	Coal	do	7,800	650	23.00	5.31	3.82	1.04				1.29	.70	4.96	1.55	27	1
9	Coal	do	6,600	550	22.00	2.34	1.97	.88				.82	.42	2.63	1.67	27	1
10	Coal	do	5,400	450	26.00	1.20	1.22	.61				.76	.39	1.24	1.72	27	1
11	Coal	do	3,600	300	33.00	.72	.52	.28				.33	.24	.82	.60	27	1
13	Quarry	Highwall	2,033	280	24.00	.76	.66	.49						1.02		1	1
14	Quarry	do	4,353	218	61.00	.29	.22	.32	0.90		0.85					1	1
15	Quarry	do	1,995	303	52.00	.18	.22	.36						.11		2	1
16	Quarry	do	2,850	187	88.00	.49	.24	.26						.37		3	2
17	Quarry	do	5,047	200	100.00	.21		.14						.33		1	1
17	Quarry	do	5,047	200	129.00	.16								.15		4	2
18	Quarry	do	2,367	305	22.90	1.00		3.82						1.53		1	1
18	Quarry	do	2,367	305	45.70	.53								.30		4	2
19	Quarry	do	2,450	160	86.00	.44		.33						.26		5	2
19	Quarry	do	2,450	160	119.00	.50								.32		6	1
33	Quarry	do	8,762	700	124.70	.15	.13	.07						.30		7	1
33	Quarry	do	8,762	700	124.70	.05								.16		8	1
35	Iron	Highwall		4,200	17.90		1.86								1.74.	10	2
35	Iron	do		4,200	17.90	.07		.09						.45		11	2
35	Iron	do		4,200	17.90	.07		.09						.33		12	2
35	Iron	do		4,200	17.90	.07		.09						.14		13	1
36	Iron	do		21,000	132.50	.02		.01						.04		14	2
36	Iron	do				.02		.01						.06		15	1
36	Iron	do		21,000	48.30	.03								.05		16	1
37	Iron	do		2,184	85.60	.18								.38		18	1
38	Iron	do		15,530	337.80	.01		.01	.01	0.01				.02		14	2
39	Coal	do	20,300	2,300	64.00	.25	.23	.12	.42	.11	.30			.46	.97	19	2
40	Coal	Parting	648	72	767.00	.01	.01	.01						.04		19	2
41	Coal	Highwall	21,800	2,600	58.00	.28	.20	.15	.40	.24	.24			.44	.79	19	2
43	Coal	do	20,700	2,600	56.00	.30	.39	.26	.34	.14	.34			.54	1.49	19	2
43	Coal	do	20,700	2,600	43.95	.87								1.37		20	1
44	Coal	do	20,600	2,300	57.00	.21	.36	.28	.29	.10	.42			.45	1.71	19	2
44	Coal	do	20,600	2,300	47.69	.91								1.20		20	1
45	Coal	Highwall	20,700	2,300	55.00	.33	.41	.20	.32	.10	.35			.68	2.27	19	2
45	Coal	do	20,700	2,300	48.94	1.13								.73		20	1
46	Coal	Ditch	3,600	600	91.00	.07	.11	.03	.05	.03	.14			.10	.84	19	2
46	Coal	do	36,000	600	71.57	.06								.23		20	1
47	Coal	Highwall	21,600	2,600	50.00	.26	.29	.24	.25	.10	.71			.54	1.09	19	2
47	Coal	do	21,600	2,600	47.32	1.10								.93		20	1
48	Coal	do	20,600	2,300	51.00	.24	.33	.25	.19	.10	.80			.48	1.00	19	2
48	Coal	do	20,600	2,300	51.71	.79								.68		20	1
49	Coal	do	19,800	2,200	54.00	.39	.28	.22	.28	.19	.29	.61	.35	1.07		20	1
50	Coal	do	19,700	2,200	56.00	.24	.15	.25	.22	.17	.36	.40	.28	.87		20	1
51	Coal	do	19,300	2,200	57.00	.13	.14	.13	.11	.08	.21	.26	.13	.67	.32	20	1
53	Coal	Parting	264	24	621.00	.01	.01	.01	.00	.01	.01	.01	.01	.05		20	1
54	Coal	do	360	36	425.00	.02	.02	.01	.01	.01	.01	.03	.01	.02		20	1
55	Coal	Highwall	18,400	2,100	60.00	.14	.13	.18	.13		.30	.21		.51	.36	20	1

56	Coal	do	17,700	2,000	64.00	.16	.08	.15	.08	.23	.16	.26	.51	20	1
57	Coal	do	6,000	2,000	65.00	.18	.08	.12			.18	.21	.18	20	1
58	Coal	Parting	480	30	444.00	.02	.01	.01			.02	.05	.02	20	1
59	Coal	do	294	30	788.00	.01	.01	.01			.01	.01	.01	20	1
60	Coal	Highwall	21,400	2,000	38.00	.49	.32	.88			.98	.31	.20	19	2
61	Coal	do	24,700	2,100	35.00	.44	.90	.93		.65	.93	.42	.30	19	2
62	Coal	Sweetner	1,500	150	138.00	.12	.20	.06		.23	.09	.12	.06	19	2
64	Coal	Highwall	24,600	2,100	33.00	.51	.62	.85		.51	.96	.43	.26	19	2
65	Coal	do	15,700	2,200	30.00	.45	.59	1.06		.47	1.06	.76	.26	19	2
66	Coal	do	15,800	1,900	31.00	.62	.77	1.53		.54	1.56		.30	19	2
67	Coal	do	13,540	1,900	29.00	.66	.81	.78		.59	.89	.25	.30	19	2
68	Coal	Parting	300	30	713.00	.01	.01	.01		.01				19	2
69	Coal	Highwall	11,040	2,000	26.00	.53	.70	.94		.45		.29	.26	19	2
70	Coal	Sweetner	2,100	300	86.00	.19	.16	.07		.11	.10	.12	.04	19	2
71	Coal	Hilltop	9,020	410	67.00	.21	.28	.17		.27	.26	.17	.10	19	2
72	Coal	Ditch	3,060	510	93.00	.07	.09	.03		.03	.07	.07		19	2
73	Coal	Highwall	19,600	2,000	24.00	1.24	1.24	2.24	.78	.97	2.22	.44	.33	19	2
74	Coal	do	17,100	2,000	23.00	.75	1.12	1.23	.62	.78	1.28	.38	.27	19	2
75	Coal	Ditch				.09	.07	.08	.07	.06		.14	.05	19	2
76	Coal	do	3,360	280	93.00	.08	.12	.12			.18	.07	.08	19	2
77	Coal	do	1,200	220	102.00	.07	.07	.05			.08	.05	.03	19	2
78	Coal	Highwall	22,200	2,100	20.00	.68	1.14	1.58		1.79	.50	.39	1.66	19	2
79	Coal	do	24,900	2,200	18.20	1.58	1.69	2.45		2.93	.87	.71	2.55	19	2
80	Coal	Highwall	25,100	2,300	16.70	1.14	1.03	0.70		1.04	.63	.54	1.09	19	2
81	Coal	Sweetner	3,240	360	37.00	.35	.45	.24		.35	.25	.21	1.08	19	2
82	Coal	Hilltop	27,000	1,000	22.00	1.98	1.85	1.65		4.01	1.34	.84	3.26	19	2
83	Coal	Ditch	2,040	340	81.00	.06	.06	.05					.06	19	2
84	Coal	Highwall	25,600	2,200	16.10	1.37	1.05	1.48		2.33	.87	.54	2.96	19	2
85	Coal	do	25,400	2,200	15.60	2.20	1.27	1.91		1.15	.87	.58	3.76	19	2
86	Coal	do	25,900	2,200	15.30	1.89	1.23	2.21		3.08	.95	.40	3.66	19	2
87	Coal	Ditch	1,320	220	98.00	.08	.05	.06		.07	.05	.03	.24	19	2
89	Coal	Parting	360	36	372.00	.01	.01	.01		.02	.02	.02	.03	19	2
90	Coal	Highwall	25,500	2,200	15.40	1.68	1.53	2.51		3.37	.94	.51	2.72	19	2
91	Coal	do	31,500	2,200	15.70	1.99	1.60	2.45		2.69	.74	.41	2.92	19	2
92	Coal	Ditch				.16	.12	.11		.19	.08	.04	.44	19	2
93	Coal	Parting	114	12	626.00	.00	.01	.00					.02	19	2
94	Coal	Highwall	30,700	2,200	17.10	.79	1.25	1.41		2.75	.63	.57	2.88	19	2
95	Coal	do	26,600	2,200	17.90	2.08	1.14	1.35		2.06	.63	.49	5.07	19	2
96	Coal	do	20,500	2,000	19.30	1.22	1.18	.99		2.41	.73	.49	3.07	19	2
97	Coal	do		450	118.00	.03	.01	.04	.06	.02			.11	21	1
98	Coal	do	14,400	450	127.00	.05	.01	.04	.04	.04			.16	21	1
99	Coal	Parting	20,880	773	50.00	.27	.19	.15	.34	.26			.61	21	1
100	Coal	do	18,000	200	53.00	1.26	.88	.72	.46	.59			1.68	21	1
101	Coal	do	17,500	350	96.00	.08	.05	.08	.13	.05			.29	21	1
102	Coal	do	27,040	208	48.00	1.20	.79		.69	.58			2.50	21	1
103	Quarry	Highwall	4,956	632	62.00	.32	.27	.19			.15	.14	.41	22	2
103	Quarry	do	4,956	632	28.00	.82	.76	.53		.67	.49	.58	.90	23	1
104	Quarry	do	5,752	632	59.00	.22	.41	.13	.47	.22	.40	.24	.55	22	2
104	Quarry	do	5,752	632	26.00	1.09	.77	.44		.60	1.04	.70	1.32	23	1
105	Quarry	do	4,350	615	22.00	.85	.61	.42		.70	.47	.52	.72	23	1
106	Quarry	do	17,604	852	144.00	.16	.19	.14	.12	.13	.26	.15	.44	23	1
106	Quarry	do	17,604	852	79.00	.04	.03	.03	.03	.03	.03	.04	.08	22	2
107	Coal	do				.17	.26	.20	.13	.26	.29		.55	26	1
108	Coal	do				.21	.20	.24	.21	.17	.20	.37	.22	28	1
109	Coal	do		300	105.00	.09	.04	.08	.08	.15	.11	.32	.30	29	2
110	Coal	Parting	21,600	240	52.00	1.33	1.02	.52		.50	.33	.35	1.85	21	1
111	Coal	do		320	56.00	.79	.69	.34	.60	.28	.26	.57	.57	21	1
112	Coal	Highwall		300	81.00	.43	.39	.20				.28	.93	30	1
113	Coal	Parting		320	61.00	.45	.69	.33					.86	21	1
114	Coal	do	23,680	370	68.00	.47	.51	.47		.26			.93	21	1
116	Coal	Highwall	12,000	300	38.00	.24	.22	.23	.29	.25	.24	.37	.42	31	1
117	Coal	Parting	14,400	360	158.00	.04	.02	.02					.07	21	1

Table 1.—Production blasts and ground vibration measurements—Continued

Shot	Facility	Shot type	Total charge, lb	lb per delay	Scaled Scaled distance, ft/lb ^{1/2}	Peak ground vibration, in/sec			Peak structure motion, in/sec						Structure number (table 3)	Structure type		
						H ₁	H ₂	V	Low corner			High corner		Midwall				
									H ₁	H ₂	V	H ₁	H ₂	H ₁			H ₂	
119	Quarry	Highwall	16,608	782	154.00	0.03	0.04											
120	Coal	do	15,120	120	137.00	.19	.09	0.11	0.25	0.09	0.18	0.04	0.04	0.04	0.11	32	2	
122	Coal	do		15	430.00	.03	.05	.03	.02	.02	.02	.09	.13	.17	.27	28	1	
124	Coal	Parting	1,340	20	447.00	.02	.02	.02	.03	.09	.05	.04				33	2	
125	Coal	Highwall	10,200	200	141.00	.13	.13	.21	.09	.09	.01	.16		.72	.32	33	2	
126	Coal	Parting	1,200	20	391.00	.02	.02	.03	.01	.02	.02					34	1	
127	Coal	Highwall	12,000	400	88.00	.16	.13	.08	.15	.11	.16			.34	.36	34	1	
129	Coal	do	15,000	350	166.00	.06	.09	.04	.06	.05	.06			.36	.30	35	1	
130	Coal	Parting	890	20	391.00	.02	.02	.01	.05	.04	.07			.36	.30	35	1	
131	Coal	Highwall	10,800	400	88.00	.15	.14	.10	.11	.10	.20			.04	.05	34	1	
132	Coal	Parting	1,300	30	219.00	.05	.06	.04	.04	.03	.03	.09	.09	.36	.24	34	1	
133	Coal	Highwall	24,000	400	60.00	.07	.07	.04	.07	.05	.05			.24	.13	33	2	
134	Coal	Parting	2,300	400	60.00	.23	.36	.16	.22	.19	.12	.32	.23	.49	.49	33	2	
135	Coal	do				1.14	1.00	.02	.76	.66	.75	.61	.75	1.52	2.41	21	1	
136	Coal	Parting	29,700	900	16.70	1.54	1.12	1.59	.94	.65		.70	.56	2.07	1.84	21	1	
137	Coal	do	2,300	20	447.00	.03	.04	.02	.02	.02	.01	.03	.02	.20	.00	33	2	
138	Coal	do	2,300	20	447.00	.03	.04	.02	.01	.01	.01	.05	.02	.20	.04	33	2	
139	Coal	Highwall	19,200	400	100.00	.10	.12	.06	.11	.09	.07	.15	.12	.51	.20	33	2	
140	Coal	Parting	1,000	20	783.00	.00	.01	.00	.04	.04	.02	.06	.03	.06	.05	35	1	
141	Coal	do	1,000	20	537.00	.00	.00	.00		.00				.02		36	1	
142	Coal	do	1,000	20	537.00	.00	.00	.00		.01				.02		36	1	
143	Coal	Highwall	40,000	400	120.00	.06	.03	.02		.07	.03			.14	.17	36	1	
144	Coal	Parting	2,400	10	750.00	.00	.00	.01		.00	.00			.02	.01	36	1	
145	Coal	Highwall	40,000	400	120.00	.05	.05	.04	.03	.06	.05			.10	.19	36	1	
146	Iron	do		4,580	86.00	.13	.22	.09	.13					.40		37	2	
146	Iron	do		4,580	86.00	.05	.05	.04		.04				.08			2	
146	Iron	do		4,580	86.00	.13	.22	.09	.42	.20				.50	.67		1	
147	Iron	Highwall		8,800	74.00	.15	.17	.04	.15	.15	.03			.27	.22		1	
147	Iron	do		8,800	74.00	.15	.17	.04	.39	.28				.70	.62	38	2	
147	Iron	do		8,800	74.00	.15	.17	.04	.17	.11	.06			.14	.16	39	1	
148	Iron	do		8,230	74.00	.11	.11	.03	.12	.12	.03		.14	.19		38	2	
148	Iron	do		8,230	74.00		.11	.04	.11	.10	.03			.18	.19		2	
149	Iron	do	58,000	2,500	221.00	.00	.03	.00	.03	.01	.01	.04	.02	.05	.04	41	2	
150	Iron	do		3,260	102.00	.07	.11	.07	.03	.04	.02	.07	.04	.16	.14	37	2	
151	Coal	do					.02	.01	.03	.01	.01	.03	.05	.07	.05	42	2	
152	Coal	do	3,585	255	132.00		.05	.05	.05	.04	.06	.07	.08	.11	.14	42	2	
153	Coal	do	3,783	152	171.00		.09	.04	.09	.10	.06	.11	.15	.18	.25	42	2	
154	Coal	do	3,000	125	51.00		.34	.51	.55	.38	.79	.44		.98	1.26	43	2	
157	Coal	do	4,500	75	127.00		.14		.14	.11				.31		2	2	
157	Coal	do	4,500	75	52.00	.34	.44	.26	.33	.38				.48	.58		1	
158	Coal	do	2,450	41	180.00		.10		.10	.09				.25		45	2	
158	Coal	do	2,450	41	56.00	.41	.32	.25	.52	.45				.66	.61		1	
159	Coal	do	920	23	250.00		.04		.05	.03				.13		45	2	
159	Coal	do	920	23	52.00	.33	.24	.33	.27	.25				.57	.46		1	
160	Coal	do	5,460	78	51.00	.29	.23	.13	.11	.12		.17		.33	.55	47	1	
161	Coal	do	3,280	41	34.00	1.17	.64	.64	.52	.37	.66	.62		2.02	1.72	48	2	
162	Coal	do	13,040	602	61.00	.18	.19	.16	.12	.16				.41		49	2	
163	Iron	do		8,530	6.50	.73	.53	.85	.81	.99	.87	.96	.61		1.15	50	1	
164	Coal	do	3,510	351	45.00	.19	.15	.10	.16	.12	.19	.96	.61	.37	.21	49	2	
165	Coal	do	4,914	351	44.00	.25	.36	.13	.26	.25	.41	.48	.76	.64	.49	49	2	
166	Coal	do				.18	.17	.20	.13	.17	.19	.20	.23	.28	.32	49	2	
167	Coal	do	1,750	35	51.00	.33	.42	.50	.38	.43	.49	.23	.44	.86	.94	51	2	
168	Coal	do	4,300	86	27.00	.85	1.16	.72	.98	1.29	.77	.66	1.03	2.51	3.12	51	2	

169	Coal	do	4,300	86	19.20	2.11	1.81	1.45	1.92	1.34	1.27		1.86	6.50	5.10	51	2
170	Coal	do	4,300	86	16.20	2.84	1.85	1.65	1.72	1.27	1.63	1.01	1.63	3.64	3.71	51	2
171	Coal	do	1,775	71	17.80	1.23	1.24	.97	.43	.62	.72	.82	.47	2.36	.79	51	2
172	Coal	do				.20	.17	.21	.19	.26	.29			1.04	.62	49	2
174	Coal	do	4,300	86	21.00	1.38	1.86	.85	.67	1.15	1.90	1.20	2.06	3.84	2.91	51	2
175	Coal	do	5,150	212	9.90	10.21	6.92	5.65	3.18	4.02	3.19	3.89	4.09	6.99	10.27	51	2
178	Coal	do	1,320	33	45.00	1.04	.64	.83	.33	.30	.64					51	2
179	Coal	do	2,145	33	31.00	1.84	2.08	1.47	1.38	1.32	1.78					51	2
180	Coal	do	1,620	18	4.00	10.58	2.02	2.92	3.69	1.33	2.12					51	2
181	Coal	do	1,980	22	18.50	7.25	4.90	4.76	1.65	2.55	2.75					51	2
182	Coal	do	1,620	18	3.30	6.37	3.46	3.46	3.06	2.60	2.70					51	2
183	Coal	do	2,375	125	206.00	.02	.02	.02	.02	.02	.02			.16		52	1
186	Coal	do	350	35	127.00	.06	.04	.03	.05	.03						54	1
187	Coal	do	350	35	127.00	.04	.04	.04	.06	.03						54	1
189	Coal	Highwall	360	40	119.00	.05	.03	.07	.04	.01						54	1
190	Coal	do	720	40	119.00	.06	.03	.03	.06					.22	.06	54	1
191	Coal	do	400	40	119.00	.04	.02	.06						.06	.07	54	1
192	Coal	do	960	40	119.00	.06	.03	.05						.18	.07	54	1
193	Coal	do	3,780	60	36.00	2.67	2.11	3.20	.81	.72				.72	.07	55	2
194	Coal	do	320	40	174.00	.02	.02	.02				.01		.07		56	2
195	Coal	do	424	40	174.00	.02	.01	.02				.01		.08		56	2
196	Coal	do	680	40	174.00	.03	.02	.03	.02			.02		.12		56	2
197	Coal	do	4,160	80	38.60	.80	.94	.59								49	2
198	Coal	do	1,200	30	32.90	1.02	.92	.43								57	1
199	Coal	do	1,200	30	31.00	1.08	.98	1.20								57	1
200	Coal	do	5,510	276	66.20	.25	.35	.25								49	2
201	Coal	do	1,200	30	28.70	1.19	1.13	.77								57	1
202	Coal	do	1,200	30	25.00	2.06	1.13	1.29								57	1
203	Coal	do		100	24.70	1.35	.77	.58								58	1
204	Coal	do		100	24.20	2.23	.68	.65								58	1
205	Coal	do		100	24.20	1.05	.66	.39	.85		1.00				.43	58	1
206	Coal	do	1,800	100	24.50	.73	.75	.55		.75				.87		58	1
207	Coal	do	1,800	100	24.50	1.88	1.76	.49		1.02	.50			.76		58	1
208	Coal	do		80	19.00	1.45	1.38	1.92								58	1
W 1	Constr	Excavation	80	6	65.30	.18	.21	.26				.04	.06	.31	.27	59	1
W 2	Constr	do	14	2	45.40	.49	.58	.67	.44	.04		.28	.12	.92		60	2
W 3	Constr	do	12	1	60.00	.05	.03	.03	.02				.01	.02		60	2
W 4	Constr	do	110	7	60.50	.68	.60	.77	.39	.69	.36	.18	.29	.45		61	1
W 5	Constr	do	110	7	20.80	1.94	2.03	2.23			1.84	.57	.47			61	1
W 6	Constr	do	32	6	30.60	.35	.19	.29		.31	.27	.09	.18		.28	62	2
W 7	Constr	do	120	12	46.20	.24	.23	.10	.23	.21	.14	.15	.09	.47	.64	63	2
W 8	Constr	do	100	6	49.00	.27	.27	.13	.19	.13	.10	.14	.06	.39	.37	63	2
W 9	Constr	do		1	49.20	.04	.06	.08		.07	.05	.05	.03	.20	.26	64	2
W 10	Constr	do	4	1	30.00	.11	.10	.22	.22	.21	.20	.12	.06	.38	.32	64	2
W 11	Constr	do	18	4	98.90	.37	.32	.40	.15	.07	.06	.09	.07		.14	65	1
W 12	Constr	do	20	4	96.20	.25	.20	.22	.07	.06	.08	.07	.07		.20	65	1
W 13	Constr	do	27	8	17.50	.47	1.09	.52		.73	.41	.24	.47		1.81	66	1
W 14	Constr	do	30	9	23.00	.40	.40	.40		.65	.31	.38	.47		1.30	66	1
W 15	Constr	do	30	9	25.40	.15	.32	.18		.27	.14	.24	.32		.72	66	1
W 16	Constr	do	41	12	11.50		2.47	1.25	1.30	.64	1.17	.40	.18	1.18	1.01	67	2
W 18	Constr	do	119	10	44.80	.46	.69	.51		.11	.13	.18	.16	.22	.17	68	1
W 19	Constr	do	127	10	36.80	.72	.84	.93	.19	.47	.31	.21	.25	.29	.21	68	1
W 20	Constr	do	22	3	39.20	.53	.53	.30		.20		.14	.09	.28	.34	69	1
W 21	Constr	do	24	3	16.60	1.09	.77	.80	.19	.24	.12	.15	.17	.62	.64	69	1
W 22	Constr	do	46	7	38.50	1.56	.76	1.43	.54	.32	.45	.15	.13	.56	.55	70	1
W 23	Constr	do	42	7	11.70	3.73	2.08	3.20	2.49	1.44	2.70	.77			1.53	71	1
W 24	Constr	do	51	6	28.00	.64	.81	1.76		.55	.48	.73	.26	.41	.52	72	2
W 25	Constr	do	50	6	63.30	.96	.85	.49	.30	.21	.39	.26	.43	.65	.24	73	1
W 26	Constr	Excavation	70	76	64.00	1.61	1.32	.67	.47	.27	.58	.47	.53	.92	.26	73	1
W 27	Constr	do	70	6	61.20	1.16	1.20	.75	.38	.42	.25	.32	.46	.63	.25	73	1
W 28	Constr	do	43	5	41.60	1.14	.85	1.26	.62	.73	.52	.71	.17	1.09		74	1
W 29	Constr	do	58	7	30.20		1.44	1.80	.84	1.04	.70	.85	.29	.89	1.46	74	1
W 30	Constr	do	27	6	42.60	.27	.28	.21	.04	.17	.07	.09	.07	.30	.40	75	1
W 31	Constr	do	85	6	65.30	.53	1.22	.75	.23	.32	.39	.12	.29	.15	.89	76	1
W 32	Constr	do	85	6	32.00	1.82	1.19	1.55	.46	.50	.73	.15	.47	.19	1.09	76	1

* 20 → PPV = 438(50)^{-1.52}

Table 2.—Equations and statistics for ground vibration propagation

Site and component	Equation	Correlation coefficient	Standard error, pct
Site A:			
Maximum horizontal	GV = 84.5 (D/W ^{1/2}) - 1.324	NA	NA
Vertical	GV = 134.1 (D/W ^{1/2}) - 1.569	NA	NA
Radial:			
Site 1	GV = 82 (D/W ^{1/2}) - 1.324	0.977	35
Site 2	GV = 68 (D/W ^{1/2}) - 1.324	.971	35
Site 6	GV = 54 (D/W ^{1/2}) - 1.495	.973	35
Site 7	GV = 44 (D/W ^{1/2}) - 1.447	.902	85
Site 8	GV = 135 (D/W ^{1/2}) - 1.475	.981	42
Site 9	GV = 281 (D/W ^{1/2}) - 1.729	.980	47
Site 19	GV = 79.2 (D/W ^{1/2}) - 1.383	.937	41
Vertical:			
Site 1	GV = 137 (D/W ^{1/2}) - 1.531	.973	52
Site 2	GV = 80 (D/W ^{1/2}) - 1.531	.968	52
Site 6	GV = 56 (D/W ^{1/2}) - 1.333	.960	52
Site 7	GV = 79 (D/W ^{1/2}) - 1.676	.972	34
Site 8	GV = 110 (D/W ^{1/2}) - 1.312	.963	29
Site 9	GV = 298 (D/W ^{1/2}) - 1.823	.984	42
Site 19	GV = 335 (D/W ^{1/2}) - 1.825	.942	54
Transverse:			
Site 1	GV = 64 (D/W ^{1/2}) - 1.234	.951	66
Site 2	GV = 51 (D/W ^{1/2}) - 1.234	.931	66
Site 6	GV = 55 (D/W ^{1/2}) - 1.362	.975	44
Site 7	GV = 40 (D/W ^{1/2}) - 1.425	.944	54
Site 8	GV = 50 (D/W ^{1/2}) - 1.237	.937	45
Site 9	GV = 106 (D/W ^{1/2}) - 1.480	.940	59
Site 19	GV = 64.2 (D/W ^{1/2}) - 1.381	.946	37
All Bureau of Mines coal mine data:			
Maximum horizontal	GV = 133 (D/W ^{1/2}) - 1.50	.933	83
Vertical	GV = 79 (D/W ^{1/2}) - 1.46	.923	88
Total	GV = 119 (D/W ^{1/2}) - 1.52	.936	92
Mines¹:			
Radial	GV = 52 (D/W ^{1/2}) - 2.37	NA	58
Vertical	GV = 51 (D/W ^{1/2}) - 2.49	NA	59
Transverse	GV = 73 (D/W ^{1/2}) - 3.13	NA	55
Quarries¹:			
Radial	GV = 14 (D/W ^{1/2}) - 1.22	NA	57
Vertical	GV = 13 (D/W ^{1/2}) - 1.31	NA	61
Transverse	GV = 10 (D/W ^{1/2}) - 1.11	NA	57
Construction¹:			
Radial	GV = 5.0 (D/W ^{1/2}) - 1.09	NA	85
Vertical	GV = 8.9 (D/W ^{1/2}) - 0.99	NA	72
Transverse	GB = 5.9 (D/W ^{1/2}) - 1.12	NA	80

NA = Not available
 GV = Ground vibration, in/sec.
¹ From Lucole and Dowding (29).

D = Distance, ft.
 W = Charge weight per delay, lb.

All Bureau coal mine vibration data are shown in figure 10. A vibration level of 1.0 in/sec was typically observed at a square root scaled distance of 23 ft/lb^{1/2} and never observed beyond 60 ft/lb^{1/2}. The equivalent scaled distances for 0.5 in/sec peak particle velocity are 38 and 80 ft/lb^{1/2}. Wiss found that square root and cube root scaled distances required to enclose or envelope all his vibration data at 1.0 in/sec were 75 ft/lb^{1/2} and 300 ft/lb^{1/3}, respectively (56). Two standard deviations of the summary data in figure 10 should leave roughly 2.5 pct of the points outside the upper limit. This corresponds to scaled distances of 55 and 90 ft/lb^{1/2} at 1.0 and 0.5 in/sec, respectively. As alternatives to vibration monitoring or for statistical predictive purposes, the maximums represented by the envelopes (e.g., fig. 10) or two standard deviations from the mean regressions can be used; however, these will result in conservative vibration levels.

The Bureau of Mines coal data, as well as all of Lucole's (29), consist of relatively few measurements at each of a large variety of sites. Con-

sequently, the pooled data representing each industry as a whole tends toward large scatter (high standard deviations).

Both Wiss (56) and Nicholls (37) utilized arrays of gages and found that the propagation from individual sites could reliably be quantified (fig. 7-9) and that vibration levels for individual sites could be reasonably predicted from scaled distances.

VIBRATION COMPARISONS: MINE AND QUARRY BLASTS

Vibrations from quarry blasting have been discussed extensively in Bulletin 656 (37). That report recommended two scaled distances intended to prevent the exceeding of 2 in/sec. For a site where propagation conditions were shown to be normal, a square root scaled distance of 20 ft/lb^{1/2} was recommended. In the absence of any vibration monitoring, a scaled distance of 50 ft/lb^{1/2} was to be used, based on the envelope of maximum observed values.

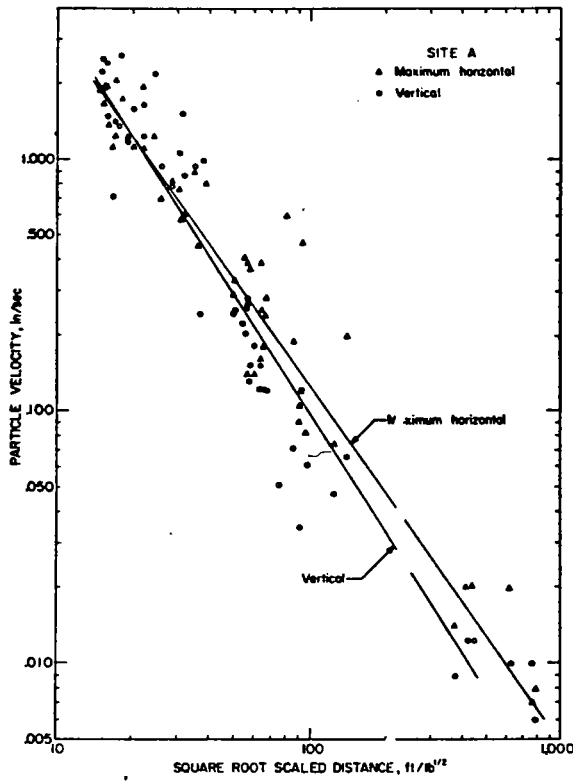

Figure 6.—Ground vibrations from a single coal mine. Equations are given in table 2.

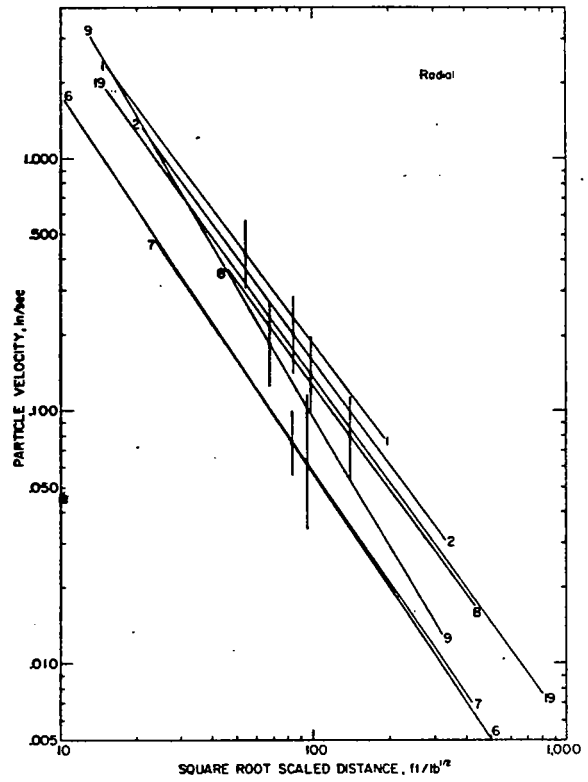

Figure 7.—Radial ground vibration propagations from surface coal mines.

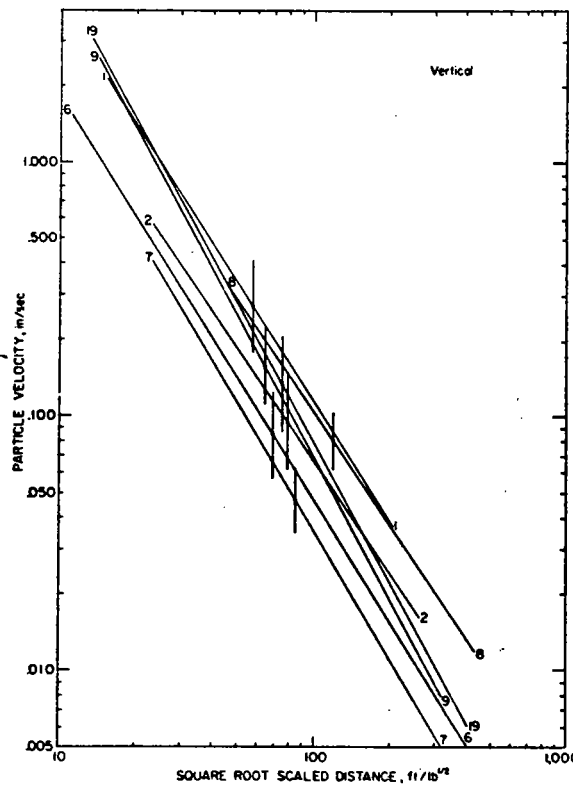

Figure 8.—Vertical ground vibration propagations from surface coal mines.

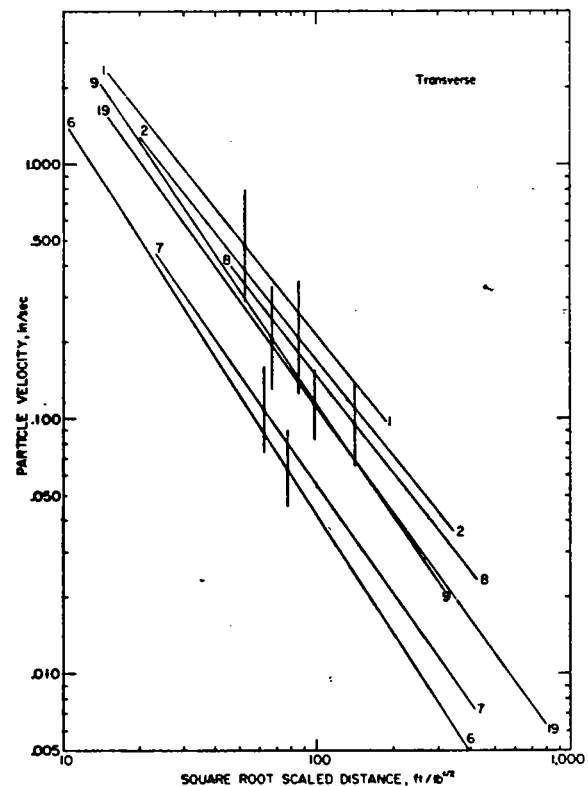

Figure 9.—Transverse ground vibration propagations from surface coal mines.

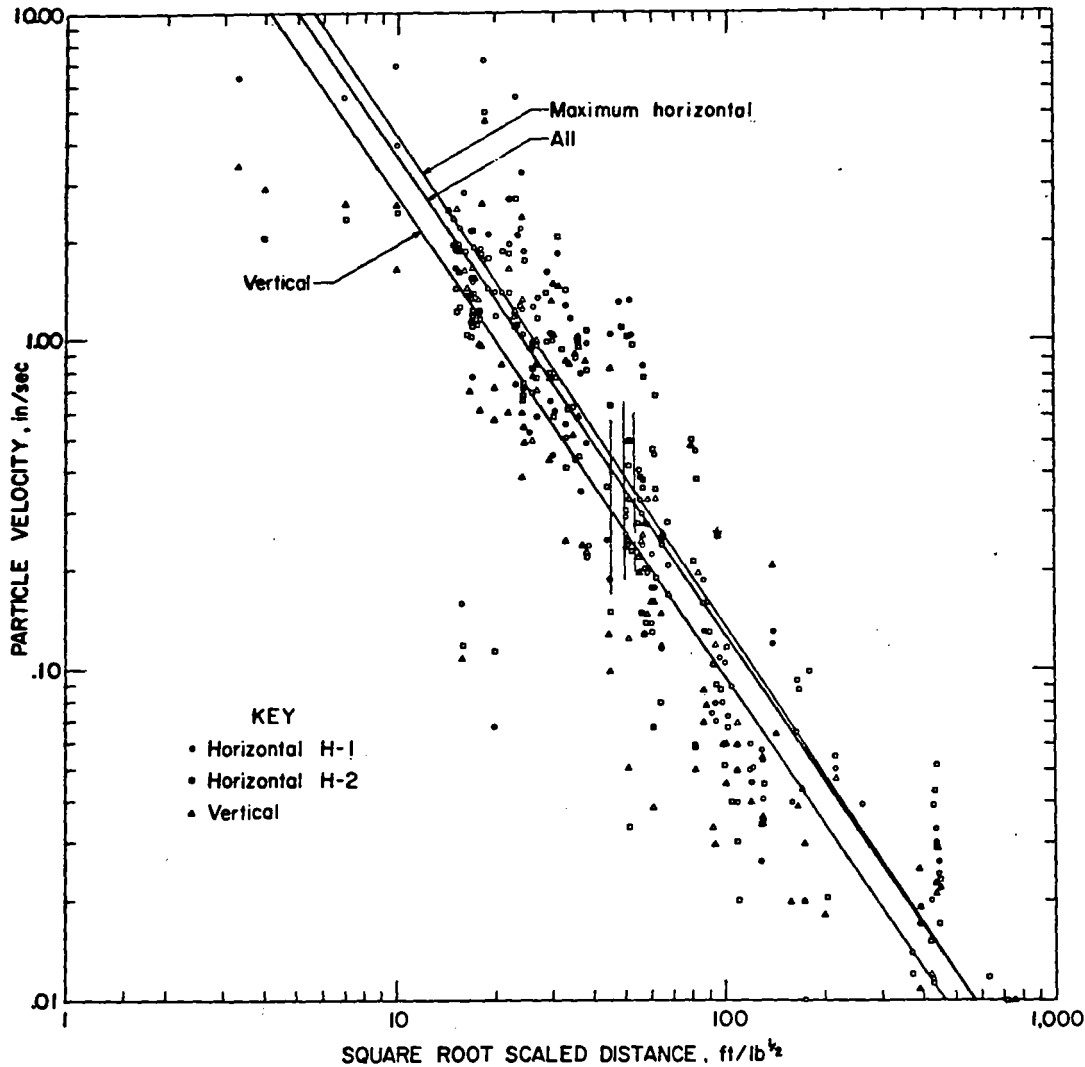

Figure 10.—Summary of ground vibrations from all surface coal mines. The component H-1 approximates “radial” and H-2 “transverse”.

The overall zones encompassing the propagation regression lines for the radial motion (usually the largest) for coal mine and quarries are shown in figure 11. It is obvious that the vibration levels for coal and quarry blasting are similar, particularly at the smaller scaled distances that warrant most concern. Contrary to expectations, the coal mine vibrations were of greater amplitude than quarry vibrations at larger scaled distances. This is probably the result of larger absolute distances involved (for the relatively large charge weights) and the possible existence of slower decaying surface waves and dispersion-produced interference between de-

lays at these distances. The Lucole study found different relative amplitudes between coal and quarry blasting to be more in agreement with the theoretical predictions (fig. 12). However, their data were also characterized by larger scatter and only a rough approximation to a Gaussian distribution (29). Their maximum envelope at 1.0 in/sec. exceeded 200 ft/lb^{1/2} for all kinds of blasting. Two standard deviations (95 pct) of the propagation data at 2 in/sec was less than 41 ft/lb^{1/2} for coal mines and 33 ft/lb^{1/2} for quarries and construction. These are both significantly lower than the Bureau's coal mine summary value of 55 ft/lb^{1/2} from figure 10.

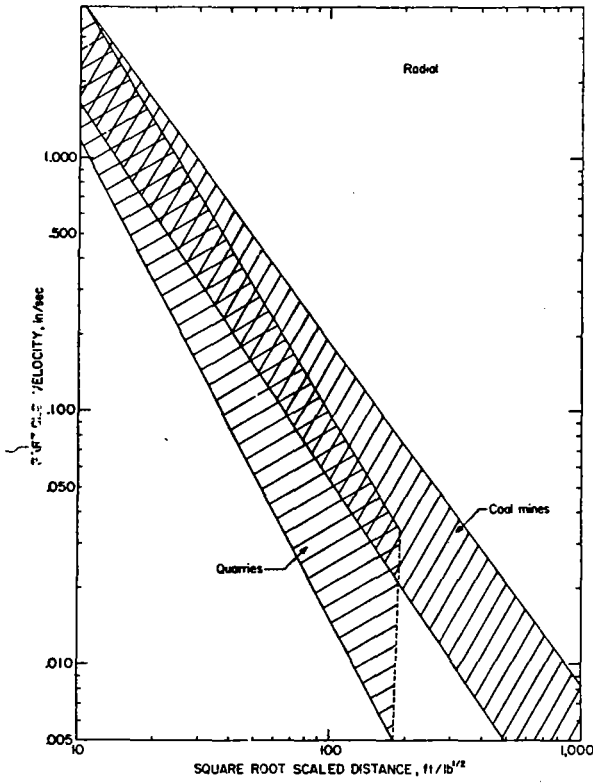

Figure 11.—Zones of mean propagation regressions for two major types of blasting.

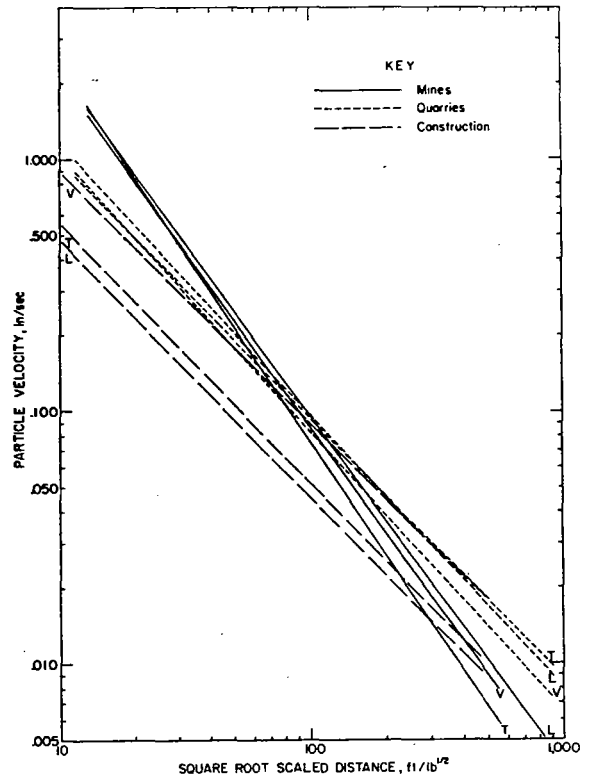

Figure 12.—Ground vibration propagation for three types of blasting as found by Lucole (29). Longitudinal (L), transverse (T), and vertical (V) components.

RESPONSE OF RESIDENTIAL STRUCTURES

The measured response of residential structures is a critical indicator of troublesome or potentially damaging ground vibrations. **Corner motion** measurements were used to assess the racking motions (shearing) of the gross structure (fig. 13). Essentially, cracking from blasts occurs where excessive stresses and strains are produced within the planes of the walls or between walls at the corners. Consequently, the vibration in the corners is assumed to indicate cracking potential, because it corresponds to whole-structure response. Other types of response cause different but consequential results. Midwall motions (normal to the wall surface) were also measured and are primarily responsible for window sashes rattling, picture frames tilting, dishes jiggling, and knick-knacks falling. Structures are designed to resist normal vertical load; however, differential vertical motions can produce high strains in floors and ceilings. Vertical floor motions are also of concern for potential human response.

RESPONSE SPECTRUM ANALYSIS TECHNIQUES

A simple method for predicting structural responses to vibrations has developed from studies of building response to earthquakes. It is based upon the single degree of freedom (SDF) model of a structure shown in figure 13 (8, 10, 13, 24, 30, 32, 42). The relative displacement between the mass and the ground, $u(t)$, can be mathematically calculated from a knowledge of the time-varying ground displacements, $y(t)$. The simplifying assumptions behind this mathematical idealization are as follows:

1. The structure can be represented by a lumped mass, m .
2. The relative displacement and deformation of the structure produces a restoring force proportional to the stiffness of the structure, k .
3. During vibration, energy is dissipated through viscous friction, C , which is constant regardless of the amplitude of the motion.

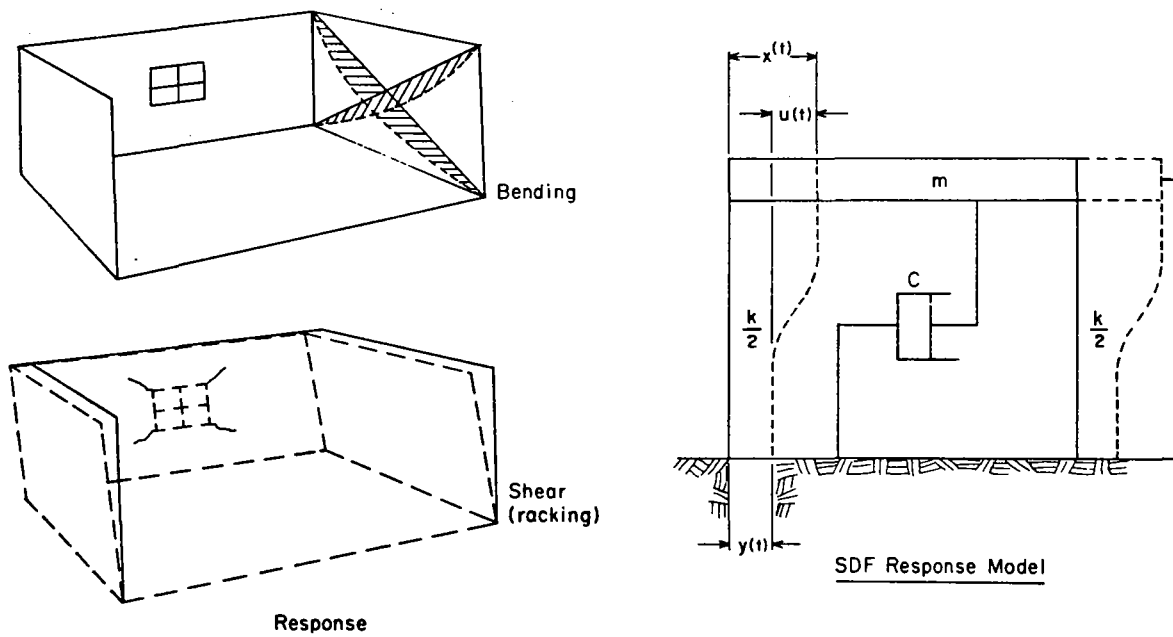

Figure 13.—Single degree of freedom (SDF) model and types of structures response. SDF symbols are explained in the text.

4. The structure responds or translates only in a single direction—hence the name single degree of freedom (SDF). Incorporation of simultaneous torsional rotation or additional components of motion requires additional degrees of freedom.

In an actual structure, m is the mass of the walls, floor, and roof; the restoring force is that produced by the walls resisting shear deformation, and frictional dissipation of energy results from portions of the structure working against each other. **Nail pulling is one consequence.** The equation of motion of the SDF system, subjected to a time varying motion, is

$$\ddot{u} + 2\beta\omega_n\dot{u} + \omega_n^2u = -\ddot{y} \quad (1)$$

where \ddot{u} , \dot{u} , u , are relative acceleration, velocity, and displacement,
 \ddot{x} , \dot{x} , x are absolute acceleration, velocity, and displacement of mass,
 \ddot{y} , \dot{y} , y are absolute acceleration, velocity, and displacement of the ground,
 ω_n is the circular natural frequency (also $2\pi f_n$) and related to stiffness (k) and mass (m) by: $\omega_n = \sqrt{k/m}$, and
 β is the damping ratio (pct of critical /100) and equal to C/\sqrt{km} ,
 where C is the viscous damping and is equal to \sqrt{km} when critical.

The natural frequency, ω_n , describes the rate at which the mass will freely oscillate when displaced. The damping, β , controls the decay of the oscillation. When a structure is critically damped ($\beta = 1.0$), it will return to its equilibrium position without oscillating.

Equation 1 can be solved for the relative displacement at any time, t , when given a transient ground particle velocity time history, \dot{y} . The solution is shown in equation 2:

$$u(t) = \int_0^t \dot{y}(\tau)e^{-\beta\omega_n(t-\tau)} \left\{ \begin{array}{l} \cos[\omega_n\sqrt{1-\beta^2}(t-\tau)] \\ \frac{\beta}{\sqrt{1-\beta^2}} \sin[\omega_n\sqrt{1-\beta^2}(t-\tau)] \end{array} \right\} d\tau \quad (2)$$

When a ground particle-velocity time history, such as shown in figure 3, is processed by computer with this equation, the modeled time history is produced.

The time history produced by equation 2 is one of relative displacements, u , rather than the absolute velocity \dot{x} , which is normally measured on the structure. In this relative displacement time history there will be a maximum, u_{max} . If that maximum relative displacement is multiplied by ω_n (or $2\pi f$), the resulting product, $2\pi f u_{max}$, is called the pseudo velocity, the PSRV, or the pseudo spectral response velocity. This pseudo velocity is a close approximation of the relative velocity, \dot{u} , when the assumption of simple harmonic motion is valid.

A response spectrum of a single ground motion, such as that of a hard-rock construction blast shown in figure 14, is generated from u_{max} 's from a number of different SDF systems. Consider two different components of the same structure, the 10 Hz gross structure and the 20 Hz wall. If the ground motions, $\dot{y}(t)$, of the construction blast are processed twice by equation 2 with β held constant at 5 pct and ω_n set to $2\pi(10)$ for the first time and $2\pi(20)$ for the second, two u_{max} 's will result: 0.01 in (0.25 mm) and 0.02 in (0.05 mm).

These u_{max} 's can be converted to two maximum pseudo velocities, $2\pi(10)(0.01) = 0.62$ in/sec (15.7 mm/sec) and $2\pi(20)(0.02) = 2.5$ in/sec (63.5 mm/sec); they are plotted in figure 14 as points 1 and 3. If the ground motions from the construction blast are processed a number of times for a variety of ω 's with β constant, the resultant pseudo velocities will form the solid line in figure 14.

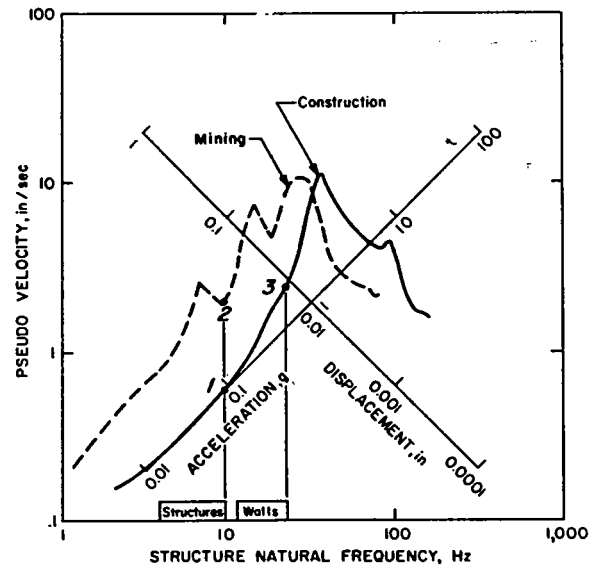

Figure 14.—Response spectra for mining and construction shots, after Corser (8).

The response spectra in figure 14 are plotted on four-axis tripartite paper. These four axes take advantage of the sinusoidal approximation involved in calculating a pseudo velocity. They are constructed so that the axis of the maximum relative displacement, u_{\max} , is inclined upward to the left such that

$$u_{\max} = PV/2\pi f,$$

where PV is the pseudo velocity, and that the axis of pseudo acceleration, PA, is inclined upward to the right such that

$$PA = PV \cdot 2\pi f.$$

The portion of a spectrum that is quasi-parallel to lines of constant displacement (less than 20 Hz for the mining blast in figure 14) is called the displacement bound. Likewise, the spectrum for the mining blast for frequencies greater than 50 Hz is the acceleration bound.

The response spectrum is similar to a Fourier frequency spectrum, since it shows the spectral content of a vibration time history. However, it is more useful as the pseudo velocity is calculated from a simplified measure of the maximum relative displacement, and as such it is related to wall strains that induce cracking.

Values of structure damping (β) must be assumed for computations of response spectra, and this value is 5 pct of critical in figure 14. This is a good approximation for a residence; however, the model response of residences is much more dependent on small changes in natural frequency than on small changes in damping (32).

Several researchers have applied response spectra techniques to blasting. Dowding examined responses from construction blasting (10). He shows the important relationship between the two frequencies (structure and ground motion) and how the ground motion descriptors of displacement, velocity, and acceleration affect response spectra of blasting vibrations. Most significant for blasting is that the principal frequencies of the ground motion almost always equal or exceed the gross structure natural frequencies of 4 to 10 Hz. This suggests either a displacement- or velocity-bound system in the 5- to 10-Hz range and supports the use of these motion descriptors to assess cracking potential. Earthquakes and nuclear blasts generate low principal frequency motions at the large distances of concern, and the 4- to 10-Hz range falls on the acceleration bound of the spectra.

Medearis developed response spectra for a variety of production blasts (30). This was one of the first attempts to show statistically that the structural response of residences (and consequently the cracking potential) is related to frequency content of the blasts. Medearis recommended safe particle velocities based on distances from the blasts that implicitly include the above-described frequency dependencies. These range from 3.20 in/sec (10 ft from a 2-story residence) to 0.62 in/sec (10,000 ft from a 1-story residence) and are based upon a 5-pct tolerance of damage. Medearis' suite of time histories was taken from quarry, excavation, and construction blasts, with an average spectral peak of 40 Hz. He therefore predicted that the relatively higher frequency 1-story homes with natural frequencies nearer 10 Hz are more damage-prone than taller 2-story homes with natural frequencies near 5 Hz. These results would not apply to mine blasts having ground vibrations at lower frequencies.

Corser calculated response spectra for a variety of blasts recorded by the Bureau of Mines (8). He found that, in the 5- to 10-Hz range (fundamental frequencies for wood frame structures), mining blasts generated SDF relative displacements that averaged 5.7 times (2.9 to 9.3) those of close-in construction shots. The time histories analyzed had peak particle velocities of 0.66 to 2.23 in/sec. Since the relative structure velocities will have similar ratios, the safe vibration levels for these two classes of blasts could differ by that same factor (5 to 6).

Figure 14 compares spectra from ground motions generated from surface coal mining and construction blasting in hard rock. Even though these two blasts produced peak particle velocities of 2.3 in/sec, the gross structure of a 1-story residence (represented by the 10 Hz response) would respond to the surface mining vibrations with relative displacements 3 times that of the higher frequency motions produced by the construction blasts.

Response-spectra analysis techniques are a powerful tool for research, engineering, and design because they include the important frequency effects. They can predict responses of a variety of structures for any type of time history. However, they do have some serious limitations in that their validity depends on how closely the structures fit the SDF model. They are not required for situations where responses can be determined empirically. They are not practical for regulatory purposes, as they are too

complex and time consuming for agencies responsible for measurement and monitoring compliance. Where responses and damage potentials have been established for one type of structure, response spectra analysis allows predictions for quite different structures with unknown vibration character. Since taller structures better fit the SDF model, these techniques have been used widely for predictions of earthquake and nuclear blast effects on such structures.

DIRECT MEASUREMENT OF STRUCTURE RESPONSES

Measurements were made of structure motions, produced by both the ground-borne vibration and airblast, as part of the assessment of potentially damaging blasts. The measurement and recording systems have been described in Bureau reports (45, 50). Both ground and structure measurements were made with 2.50- and 4.75-Hz velocity transducers (Vibra-

Metrics⁶ 120 and 124) with flat frequency responses (-3 dB) of 3 to 500 Hz and 5 to 2,000 Hz, respectively. A few accelerometers, having low-frequency response down to 1 Hz, and a variety of blasting seismographs were used (50).

Test Structures

A total of 76 different structures were studied for ground vibration and airblast response and damage (table 3). All were houses except Nos. 13, 15, 16, and 50, which were 1- and 2-story structures somewhat larger than single-family residences, and No. 54, which was a mobile home. Some structures (Nos. 19 and 20) were studied in conjunction with highwall, parting, and surface blasts. The response of structures 1-6 was described in an earlier study (45). Of the 76 structures, only 14 were subjected to high enough levels for significant damage and non-damage data, although levels of response were measured for every structure. The 14 significant test houses are shown in figures 15-28.

⁶ Reference to specific brand names is made for identification only and does not imply endorsement by the Bureau of Mines.



Figure 15.—Test structure 19, near a coal mine.

Table 3.—Test structures and measured dynamic properties

Structure	No. of stories	Dimensions, ft		Construction				Natural frequency of structure, Hz		Damping, pct		Midwall natural frequencies, Hz	Midwall damping, pct	Shots (table 1)
		Plan NS x EW	Overall height	Superstructure	Exterior covering	Interior covering	Foundation	N-S	E-W	N-S	E-W			
1	1	22 x 30	14	Wood frame	Wood siding	Gypsum wallboard	Full basement					16		13,14,17,18
2	1	30 x 70	14	Masonry and wood	Stone	do	do							15
3	1½	35 x 35	16	Wood frame	Brick and wood	do	Partial basement					13		16
4	2	30 x 40	22	do	Wood siding	do	Full basement					19,22		17,18
5	2	40 x 40	22	do	Brick and wood siding	do	Partial basement	8		2		19		19
6	1	40 x 40	14	do	Wood siding	do	Full basement	9				32		19
7	1	48 x 25	15	do	Asbestos siding	do	do							33
8	1	15 x 10	12	do	Wood siding	do	Concrete slab							33
9	1	61 x 29	14	do	do	do	Full basement							34
10	2	44 x 29	22	do	Asphalt sheathing	Plaster	do							35
11	2	26 x 32	30	do	Masonite siding	Gypsum wallboard	do					36		35
12	1½	27 x 36	20	do	Cedar shakes	do	do					25		35
13	1	34 x 100	16	do	Brick and stucco	do	Slab and crawlspace							35
14	1½	35 x 35	23	do	Wood siding	do	Full basement	10		7		14		56,58
15	1	125 x 25	12	Steel frame	Steel	do	Concrete slab	6		3		17		56,58
16	1	80 x 80	17	do	Brick and stucco	do	Full basement					8.3		36
17	1½	19 x 40	20	Wood frame	Wood shingles	do	do	10	9	5	7	18		37,146
18	1	44 x 28	13	do	Wood siding	do	Pillars in dirt	6	10	7	7	11.4		37,146
19	2	33 x 35	24	do	Wood siding	Plaster and lath	Partial basement	4	4	13	15	13,17	4.5,5.1	59-48,59-96
20	1½	39 x 29	21	do	do	Gypsum wallboard	Full basement	8	7	3	8	20	5.1	42-58
21	1	48 x 28	15	do	do	do	do	7	7	2	7	13.4,14.5	2.9,2.3	97-102,110, 111,113, 114,117, 135,136 103,104
22	2	27 x 76	26	do	Brick and masonite	Gypsum and paneling	Crawl space	8	6	3	4	12.3,13.1	2.0,3.0	103-105
23	1	62 x 26	14	do	Asbestos shingles	Gypsum wallboard	do	9	7	2	5	18.5		106
24	1	24 x 55	15	do	Brick	do	Crawl space	10	10	2	4			106
25	1½	41 x 24	22	do	Wood siding	do	Full basement	8	10	8	3	13.7,16.3	1.8,3.6	106
26	1	40 x 31	15	do	Aluminum siding	do	Crawl space	7	8	6	4			107
27	1	51 x 30	15	do	Wood siding	Plaster and lath	Partial basement	7	6	10	6	17,24		1-11
28	1	42 x 28	14	do	Wood and aluminum	Gypsum wallboard	Crawl space	7	8	6	4			108,122
29	2	26 x 35	22	do	Wood panel	do	do	7	8	2	2	17.7,13.0	1.1,2.2	109,120,121
30	1	34 x 48	16	do	Stone	do	Full basement							112
31	1	35 x 44	13	do	Wood siding	do	Crawl space	8	6	2	2	12.2,16.6	1.5,1.2	115,116,118
32	1½	58 x 26	22	do	Brick and masonite	Paneling and wallboard	Concrete slab							119
33	1½	69 x 27	24	do	Stone	Gypsum wallboard	Full basement	8	9	2	2	16.0,19.7	1.5,2.1	124,125,132-134,137-139
34	1	33 x 33	18	do	Asphalt sheathing	Plaster	Crawl space	7	6	3	4			126,127, 130,131
35	1	32 x 37	18	do	do	Gypsum wallboard	do	7	6	1	4			128,129,140
36	1	28 x 40	14	do	Asphalt shingles	do	do	6	7	3		14.17		141-145
37	1½	32 x 26	20	do	Wood siding	Plaster and lath	Full basement	9	10	2	2	18.5,20		146,150
38	2	28 x 32	20	Masonry and wood	Brick and aluminum	Wood paneling	Concrete slab	4	6	5	3			147,148

Table 3.—Test structures and measured dynamic properties—Continued

Structure	No. of stories	Dimensions, ft		Construction				Natural frequency of structure, Hz		Damping, pct		Midwall natural frequencies, Hz	Midwall damping, pct	Shots (table 1)
		Plan NS x EW	Overall height	Superstructure	Exterior covering	Interior covering	Foundation	N-S	E-W	N-S	E-W			
39	1	34x29	15	Wood frame	Masonite siding	Paneling and wallboard	Full basement	5	5	7		14		147
40	1½	28x31	18	do	Stucco	Plaster and lath	Partial basement	5	8	7	2	13.6		148
41	2	40x28	22	do	Wood siding	Gypsum and plaster	Full basement	10	8	4	2	16.6		149
42	1½	44x30	20	do	do	Paneling	do	5	7	5	4	11.9, 13.9		151-153
43	1½	28x46	23	do	do	do	do	8	5			18.18		154
44	1		15	do	do	do	do					11.11		155-156
45	2	55x44	32	Solid brick	Brick	Plaster on brick	do	9	10	3	3			157-159
46	1½	38x40	21	Concrete block	Concrete block	Plaster	do	10		4		11.11		157-159
47	1	87x38	15	Wood frame	Brick	Gypsum wallboard	do					12.5, 13.3		160
48	1½	36x24	22	do	Wood siding	do	do					16.7, 16.7		161
49	1½	41x35	27	do	do	Gypsum wallboard and plaster on lath	do					18.2, 18.2		162, 164-166, 172, 197, 200.
50	1	48x180	14	do	Aluminum siding	Gypsum wallboard	Concrete slab	9		2				163
51	2	50x45	28	Solid brick	Brick	Plaster on brick and lath	Full basement							167-171, 175-182
52	1	37x24	16	Wood frame	do	Wood paneling	do							183
53	1	24x35	15	do	Wood siding	do	Crawl space							184
54	1	12x60	15	Metal walls	Metal	Paneling	None							186, 187, 189-192
55	1½	40x31	23	Wood frame	Wood siding	do	Full basement							195
56	1½	34x37	20	do	Wood siding	do	do							194, 196
57	1	40x24	20	Wood frame	Aluminum siding	Plaster and lath and paneling	Sandstone blocks partial basement		8		9.6			198, 199, 201, 202, 203-209
58	1	40.4x31	26	Brick and masonry	Brick and masonry	Brick and gypsum wallboard	Masonry basement							W-1
59	1	30.5x54		Wood frame	Wood siding	Gypsum wallboard	Continuous concrete footings							W-2
60	2	54x26.5		do	Aluminum siding	do	do							W-4, W-5
61	1	28.5x55.5		do	Brick and plywood	Gypsum wallboard and plaster	Concrete block							W-6
62	2	34.5x48		do	Board and bat	Gypsum wallboard	Slab on grade	11	5	3	8			W-7, W-8
63	2	76.8x80		do	Wood siding	Plaster	Wooden piers on spread footings							W-9, W-10
64	2	34.5x48		do	Board and bat	Gypsum wallboard	Slab on grade							W-11, W-12
65	1	26x25		do	Aluminum siding	do	Continuous concrete footings	8		6				W-13, W-14, W-15
66	1	26.5x34.5		do	Wooden shingles	do	do							W-16, W-17
67	2	19.5x46.5		do	Wood siding	Wood paneling except kitchen ceilings	Concrete block	8		6				W-18, W-19
68	1	55x34		do	Board and bat	Gypsum wallboard	do							W-20, W-21
69	1	41x37.5		do	Aluminum siding	do	do							W-22
70	1	33x44.5		do	Wood panels	do	Continuous concrete footings							W-23
71	1	23.5x23.5		do	Board and bat	Unfinished	do							W-24
72	2	41.5x28.5		do	do	Wallboard paneling	do							W-25, W-26, W-27
73	1	30.5x26.5		do	Asphalt shingles	Plaster	Concrete							W-28, W-29
74	1	28x45		do	do	Wallboard	Slab and concrete block	7	7	6	9			W-28, W-29
75	1	36.5x34		do	Plywood	Gypsum wallboard	Concrete							W-30
76	1	38.5x40.5		do	Wood plank	Wallboard	do							W-31, W-32

SEE ERRATA



Figure 16.—Test structure 20, near a coal mine.



Figure 17.—Test structure 21, near a coal mine.



Figure 18.—Test structure 22, near a quarry.



Figure 19.—Test structure 23, near a quarry.

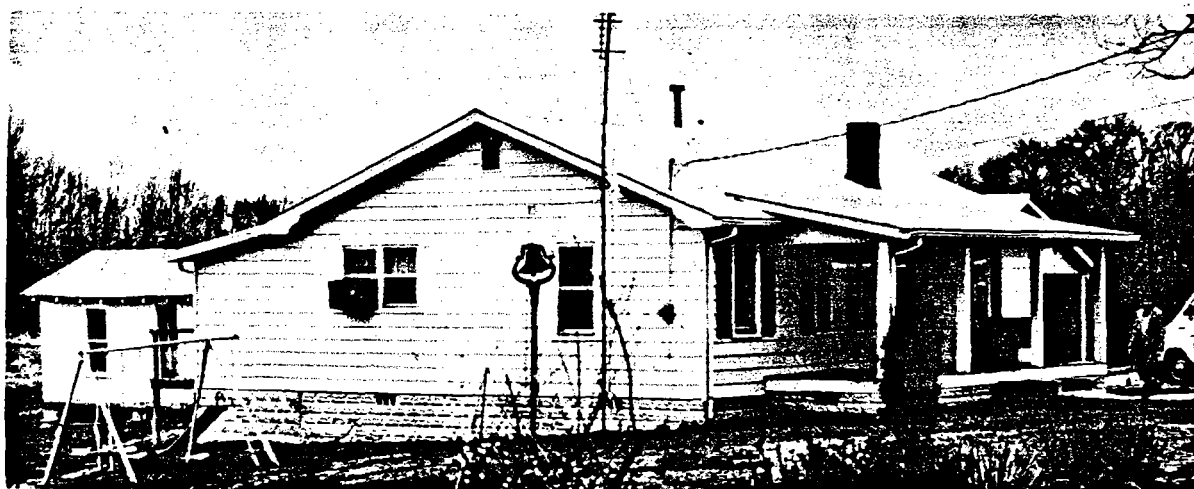

Figure 20.—Test structure 26, near a coal mine.



Figure 21.—Test structure 27, near a coal mine.



Figure 22.—Test structure 28, near a coal mine.



Figure 23.—Test structure 29, near a coal mine.



Figure 24.—Test structure 30, near a coal mine.



Figure 25.—Test structure 31, near a coal mine.

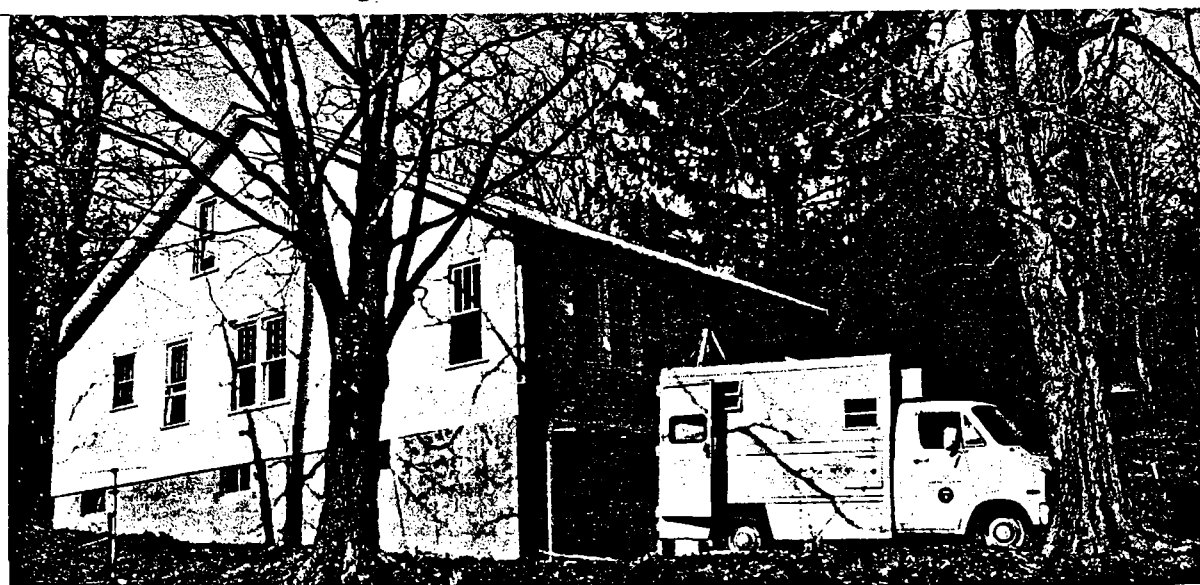

Figure 26.—Test structure 49, near a coal mine.



Figure 27.—Test structure 51, near a coal mine.

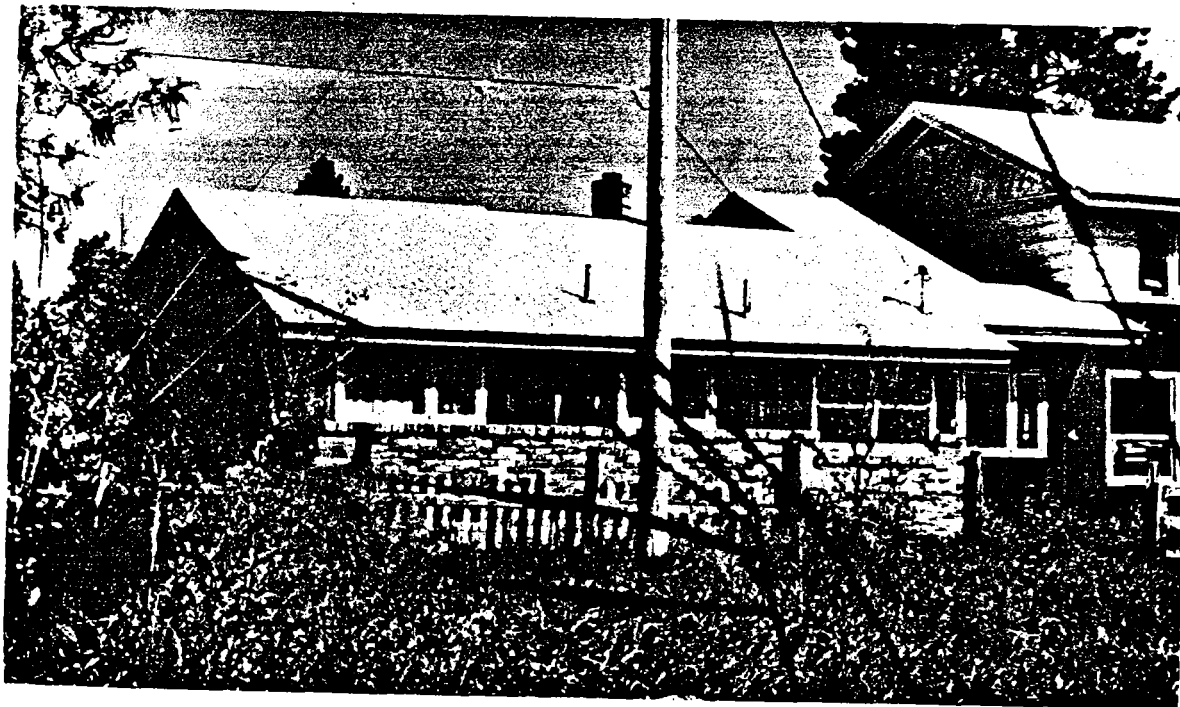

Figure 28.—Test structure 61, near a coal mine.

Construction Site

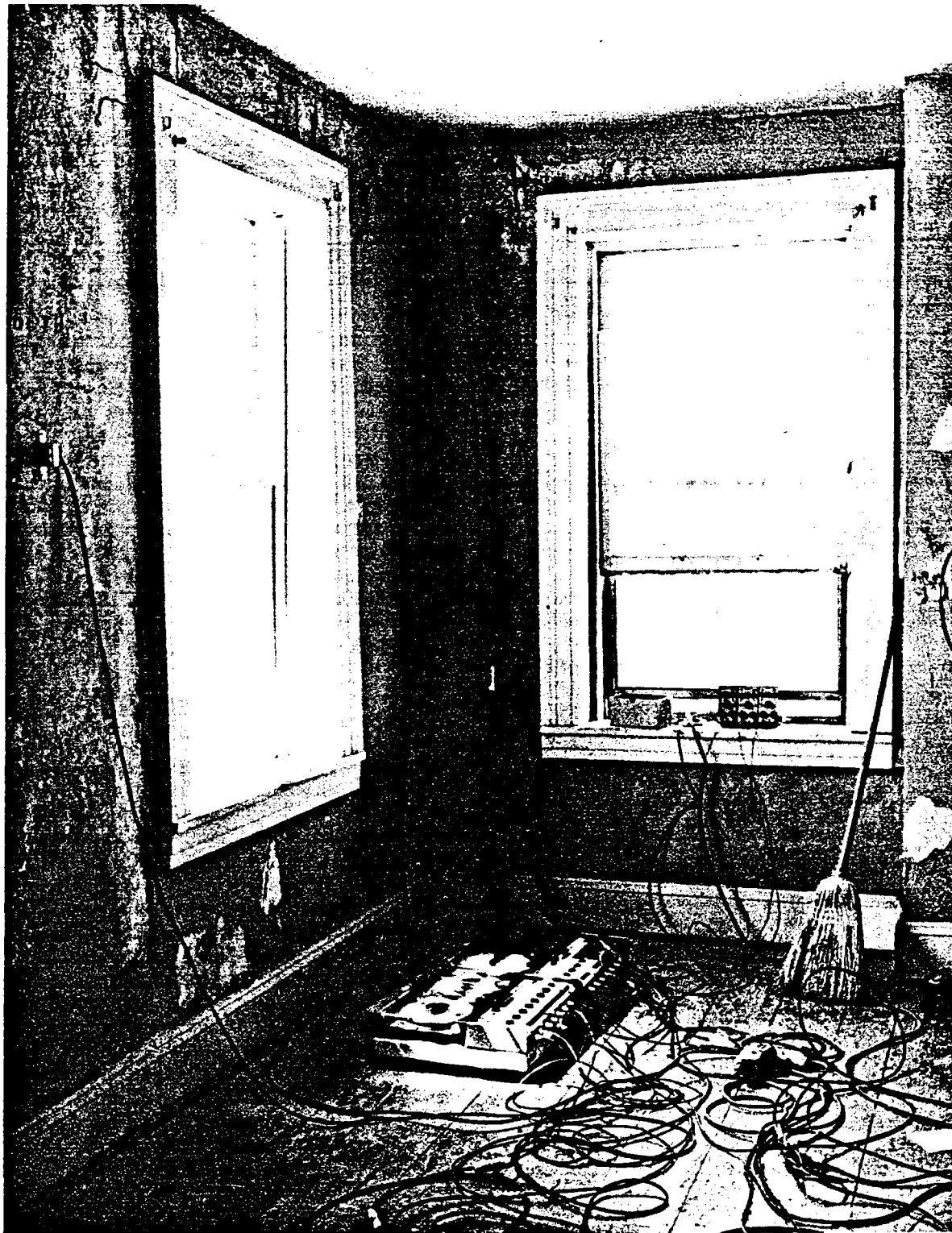

Figure 29.—Vibration gages mounted in corners and on walls for measuring structure response in structure 51.

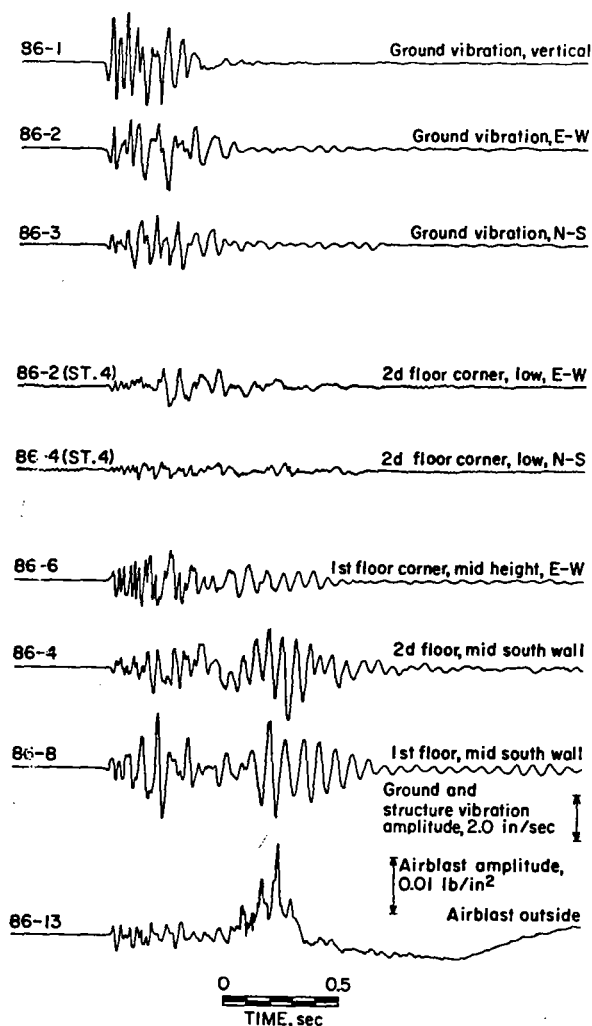

Figure 30.—Ground vibration, structure vibration, and airblast time histories from a coal mine highwall blast.

Instrumenting for Response

Outside ground vibration, airblast, structure corner, and midwall responses were measured for each shot. The ground vibration was measured by three orthogonal 2.5-Hz velocity gages buried about 12 inches in the soil next to the foundation (50). Outside airblasts were measured with at least one pressure gage and two sound level meters, one reading C-slow (46). The structures were instrumented for horizontal motions by a pair of gages mounted on the first-floor vertical walls in the corner closest to blasts and on one or more midwalls (fig. 29). Typically, the vertical motion was also measured in the same corner. Extra recording channels

that were available were used for additional corner motions (at midheights, near the ceiling, or on the next floor); additional floor motions (e.g., midfloor verticals); basement wall horizontals; opposite corner responses (for torsional motions); and inside noise. A typical set of time histories is shown in figure 30. This particular shot produced strong airblast responses of the midwalls.

Natural Frequency and Damping

Natural frequency, ω_n , and damping, β , are the most important structure response characteristics. The structural natural frequencies as measured from blast-produced corner motions are summarized in figure 31, with individual values listed in table 3. Structures continue to vibrate after the sources (ground vibration and airblast) decay, and natural frequencies and damping can be measured from these free vibration time histories. The variations of structures, especially midwalls, are approximately sinusoidal; therefore, the natural frequencies are the inverse of the periods in seconds. Damping values calculated from free vibration motions are given by:

$$\beta = \frac{100}{2\pi m} \ln(A_n/A_{n+m}),$$

where β is the percent of critical damping, A is the peak amplitude at the n^{th} cycle, and m is any number of cycles later. Dowding (13) and Langan (24) discuss the general problem of structure frequencies and damping. Their works include transfer function methods for calculating ω_n and β as well as amplitude-dependence of the damping value. Murray (32) computed many of the damping and frequency values in table 3, some of which were later reanalyzed by Langan (24).

Little difference in natural frequencies was observed among 1- and 1½-story homes; however, that for the 2-story homes was lower. Dowding (13) found average natural frequencies for the three types of homes of 8.0, 7.4, and 4.2 Hz, respectively. Medearis (30) measured frequencies and damping values for 61 houses and found similar results, except for some higher frequencies for the 1- and 1½-story homes. He found frequency ranges of 8 to 18 Hz (1-story), 7 to 14 Hz (1½-story) and 4 to 11 Hz (2-story). Damping, found by both investigators to vary between 2 and 10 pct, is summarized in figure 32.

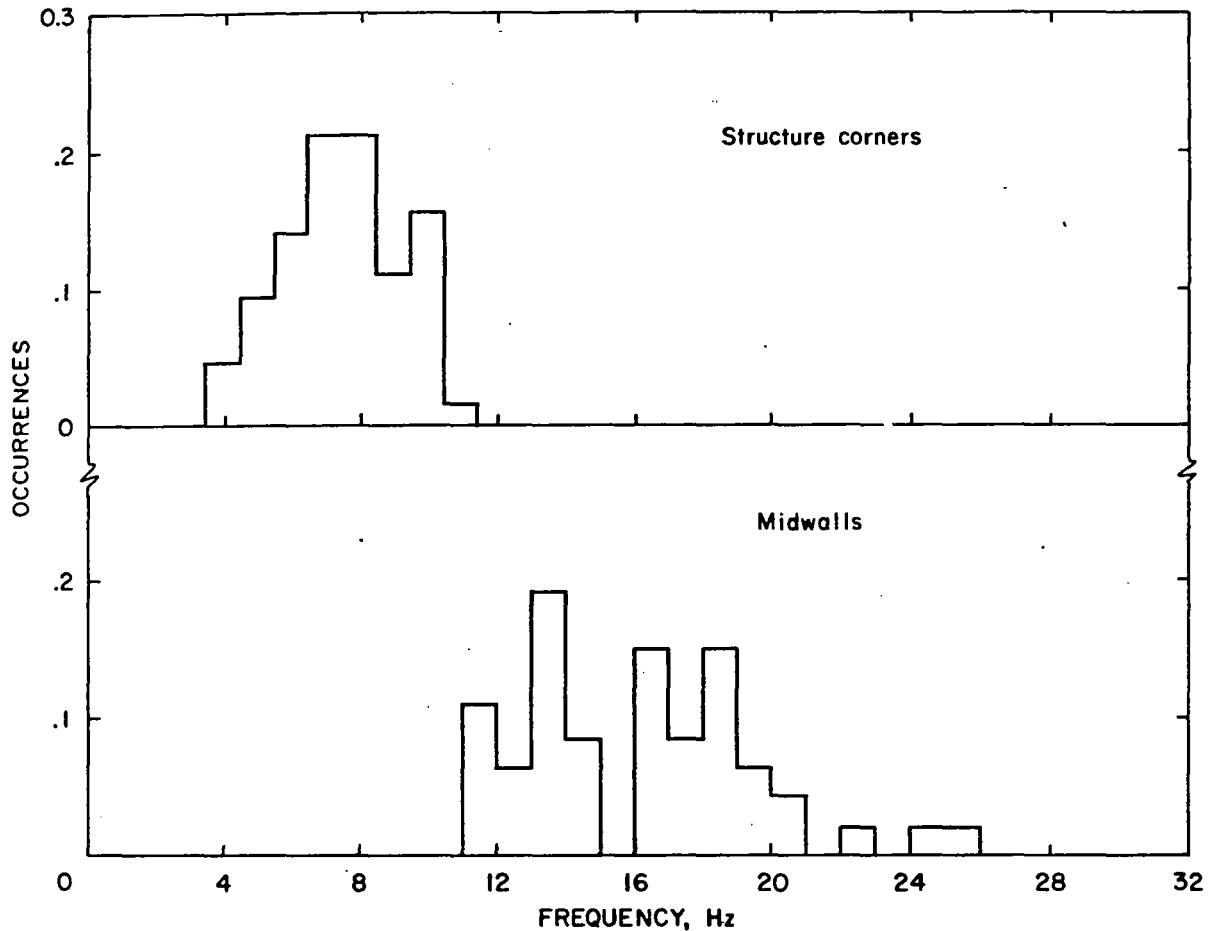

Figure 31.—Residential structure natural frequencies.

Production Blasting

Levels of structure response and incidents of damage were sought for 225 production blasts (table 2). A wide range of charge sizes, distances, geologies, and blast types produced vibrations of various peak values, durations, and frequency character. Quarries in urban areas had high free faces, used multiple decks, and had hole diameters seldom exceeding 5 in. Shots 21 to 30 were in an isolated quarry with high vibration levels at the close-in locations, but no house vibration measurements were made.

Coal mine highwall blasts varied from well-contained blasts producing no throw whatsoever; to quarry-type blasts with three free faces (top, front, and one side). Where ground vibration appeared to be more serious than airblast, design emphasis for production blasts was placed on sufficient relief (maximum number of free

faces). Parting shots involved blasting a thin and often hard rock layer, and often produced high levels of airblast and low ground vibration. An extensive study of blast design and resulting vibration levels and character was made by Wiss (56) and will not be discussed further in this report.

Velocity Exposure Levels

In addition to analyzing particle velocity time histories for peak values and frequency character, ground vibrations were also processed for velocity exposure levels (VEL), which are analogous to sound exposure levels (SEL) for noise (22, 49). These methods measure the energy of a signal within specified frequency limits and time intervals. The use of VEL to assess structure response is a possible alternative technique to using the simple peak levels of the particle

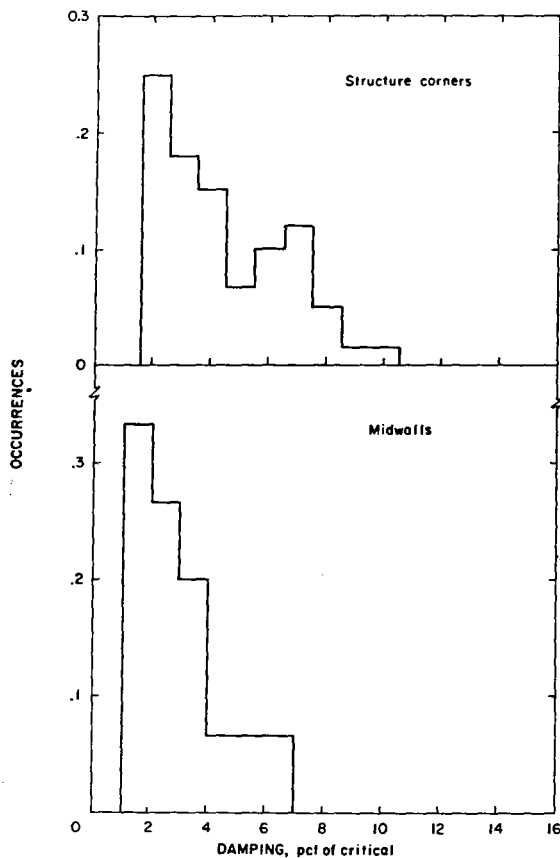

Figure 32.—Residential structure damping values.

velocity and also to response spectra techniques. The ideal VEL is normalized to 1 sec; therefore, this penalizes excessively long events (3 dB per doubling of duration) and allows higher levels for short-duration events. Current field practice involves the use of an rms system (e.g., sound level meter) with either $\frac{1}{8}$ - or 1-sec time constants and optional filtering.

Velocity exposure levels were determined for 200 of the measured blasts, with an rms detecting and filtering system described by Stachura (49) and defined by:

$$VEL = 10 \log_{10} \left[\frac{1}{t_0} \int_0^T v^2(t) dt \right]$$

where $t_0 = 1$ sec, $v(t)$ the time-varying filtered particle velocity, and T the various integration times. A filter range of 1 to 12 Hz was employed to include the range of whole-structure natural

frequencies. Integration times were $\frac{1}{8}$, $\frac{1}{4}$, 1, and 2 sec. The 1-sec time was an overall compromise that was long enough to include all the significant energy in a typical mine blast vibration measure near the source. VEL values were also determined for structure as well as ground motions.

Structure Responses From Blasting

Structure and midwall responses from production mine blasting are shown in figures 33–37, with the statistics given in table 4. In all cases, the corner and midwall responses from any given blast were plotted against the corresponding ground vibration components. The horizontal vibration components did not necessarily correspond to the true radial (or longitudinal) and transverse, since the velocity gages were oriented parallel to the structure walls.

Most interesting is that the racking response (absolute corner horizontal vibration) as shown in figures 33 and 34 is significantly lower than the input ground vibration velocity, when measured at either the first or second floor, or low or high in the corner. The vertical ground and structure corner vibrations were roughly equal as expected (figs. 33 and 36). The differences in the responses between types of blasts were significant. However, very little difference was observed between the 1- and 2-story structures.

All the responses discussed in this paper are applicable to residential-type structures with wood frame superstructures. The values do not apply to multistory steel frame structures or large structures with masonry load-supporting walls. The natural frequencies of vibration of these structures could be considerably lower than the 4 to 24 Hz range for residences and their midwalls.

The ground motion VEL did not correlate significantly better to the measured peak or VEL of the structure than the use of simple peak versus peak. Consequently it is recommended that peak velocities continue to be the primary measure of ground motion to assess the damage potential to residential-type structures and for regulatory purposes. However, it is recognized that for engineering, design, and research involving a variety of types of structures and sources, a measurement of simple peak particle velocity is an oversimplification. Some type of direct measurement of response (preferably dy-

namic strain) or model prediction (such as response spectra) would be appropriate in such cases.

Amplification Factors

Several analyses were made of structure response amplifications of the ground vibrations. The Bureau of Mines structure motion data were analyzed by Murray (32), Langan (24), and Dowding (13) for Fourier transfer functions and response characteristics. They discussed the problem of "ghost" resonances (dividing a small apparent response in the spectrum of the structure's motion by an even smaller spectral value in the ground motion).

A simpler amplification factor was determined directly from the vibration time histories. Maximum structure velocities and their times of occurrence were noted. Ground velocities and frequencies were then picked off the records at the corresponding moments of time or immediately preceding the time of the peak structure vibrations. The ratios of the two velocities are plotted in figures 38-40 against the frequency of the corresponding ground motion peak. Amplification factors for the racking response of a 1-story and a 2-story structure are shown in figure 38. Maximum amplifications were found to be associated with ground motions between 5 and 12 Hz, as expected from the natural resonance frequencies of the residences. Because

Table 4.—Equations and statistics for peak structure responses from ground vibrations

Descriptor ¹ and mine type	Stories, home	Equation	Correlation coefficient	Standard error, in/sec	Normalized std. error, in/sec	Regression line (figs. 33-37)	Number of points
Max.H SV versus Max. H GV:							
Coal	1	SV = 0.049 + 0.557GV	0.936	0.084	0.090	NAP	36
Do	2	SV = .075 + .533GV	.870	.151	.174	NAP	34
Do	All	SV = .060 + .539GV	.898	.120	.120	1	70
Construction	All	SV = .136 + .230GV	.599	.140	.234	2	13
Iron range	All	SV = .052 + .976GV	.894	.117	.130	3	10
All	1	SV = 0.87 + .455GV	.741	.169	.228	NAP	50
All	2	SV = .082 + .81GV	.862	.141	.163	NAP	53
All	All	SV = .084 + .496GV	.800	.157	.197	4	103
Vert. SV versus Vert. GV:							
Coal	1	SV = .048 + .771GV	.928	.063	.068	5	26
Do	2	SV = .070 + 1.124GV	.880	.335	.335	6	62
Do	All	SV = .044 + 1.131GV	.892	.286	.320	NAP	88
Construction	1	SV = .112 + .250GV	.568	.127	.223	7	11
Do	2	SV = .090 + .529GV	.859	.233	.271	8	7
Do	All	SV = .054 + .424GV	.741	.193	.260	NAP	18
All	1	SV = .035 + .758GV	.905	.208	.230	NAP	37
All	2	SV = .115 + .942GV	.896	.364	.406	NAP	69
All	All	SV = .073 + .907GV	.893	.330	.370	NAP	106
Max.H midwall, SV versus Max.H GV:							
Coal	1	SV = .154 + 1.347GV	.927	.228	.246	9	47
Do	2	SV = .153 + 1.636GV	.920	.358	.389	10	53
Do	All	SV = .146 + 1.534GV	.918	.310	.337	NAP	100
Construction	1	SV = .191 + .300GV	.754	.121	.160	NAP	8
Do	2	SV = .170 + .928GV	.754	.202	.268	NAP	7
Do	All	SV = .269 + .275GV	.524	.194	.371	11	15
Quarry	All	SV = .025 + 1.106GV	.886	.202	.228	12	19
Iron range	All	SV = .029 + 2.546GV	.722	.147	.203	13	16
All	1	SV = .196 + .904GV	.868	.331	.382	NAP	77
All	2	SV = .218 + 1.181GV	.776	.498	.642	NAP	82
All	All	SV = .217 + 1.002GV	.803	.431	.537	NAP	159
Coal, single home:							
Max.H SV versus MaxH GV	2	SV = .114 + .472GV	.894	.114	.161	14	35
H ₁ SV versus H ₁ GV	2	SV = .114 + .472GV	.894	.144	.161	NAP	35
H ₂ SV versus H ₂ GV	2	SV = .019 + .370GV	.906	.091	.101	NAP	37
Max.H SV versus Max VEL H GV	2	SV = .128 + 2.451GV	.812	.189	.232	15	37
H ₁ SV versus VELH ₁ GV	2	SV = .128 + 2.451GV	.812	.189	.232	NAP	37
H ₂ SV versus VELH ₂ GV	2	SV = .057 + 1.563GV	.854	.113	.132	NAP	38
Max.H SV versus TVS GV	2	SV = .110 + .299GV	.789	.143	.181	16	28
Max.HSV versus VELTVS GV	2	SV = .158 + 1.171GV	.763	.211	.276	NAP	29
Vert.SV versus Vert.GV	2	SV = .140 + 1.119GV	.852	.403	.472	17	33
Max.H midwall SV versus MaxH. GV	2	SV = .152 + 1.567GV	.905	.428	.472	18	28
Midwall H ₁ SV versus H ₁ GV	2	SV = .151 + 1.567GV	.905	.428	.472	NAP	28
Midwall H ₂ SV versus H ₂ GV	2	SV = .514 + 1.517GV	.830	.431	.519	NAP	37
Max.H SV versus PVS GV	2	SV = .092 + .267GV	.781	.128	.164	19	26

NAP = Not applicable.
¹ Symbols SV = Structure vibrations, in/sec (unless specified "midwall" all SV are corner vibrations).
 GV = Ground vibration.
 Max.H = Maximum horizontal component of vibration.
 Vert. = Vertical component of vibration.
 H₁ = Horizontal component of vibration best approximating radial.
 H₂ = Horizontal component of vibration perpendicular to H₁.
 VEL = Velocity exposure level (1-second integration, 1-12Hz).
 TVS = True vector sum.
 PVS = Pseudo vector sum.

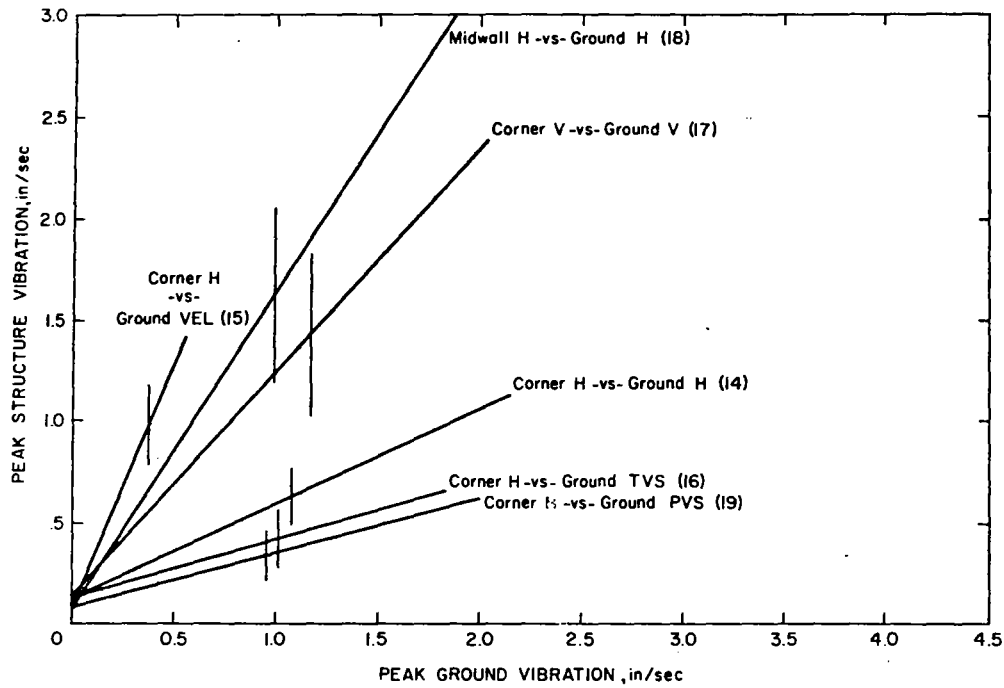

Figure 33.—Corner and midwall responses for a single structure (No. 19). Symbols, equations, and statistics are given in table 4.

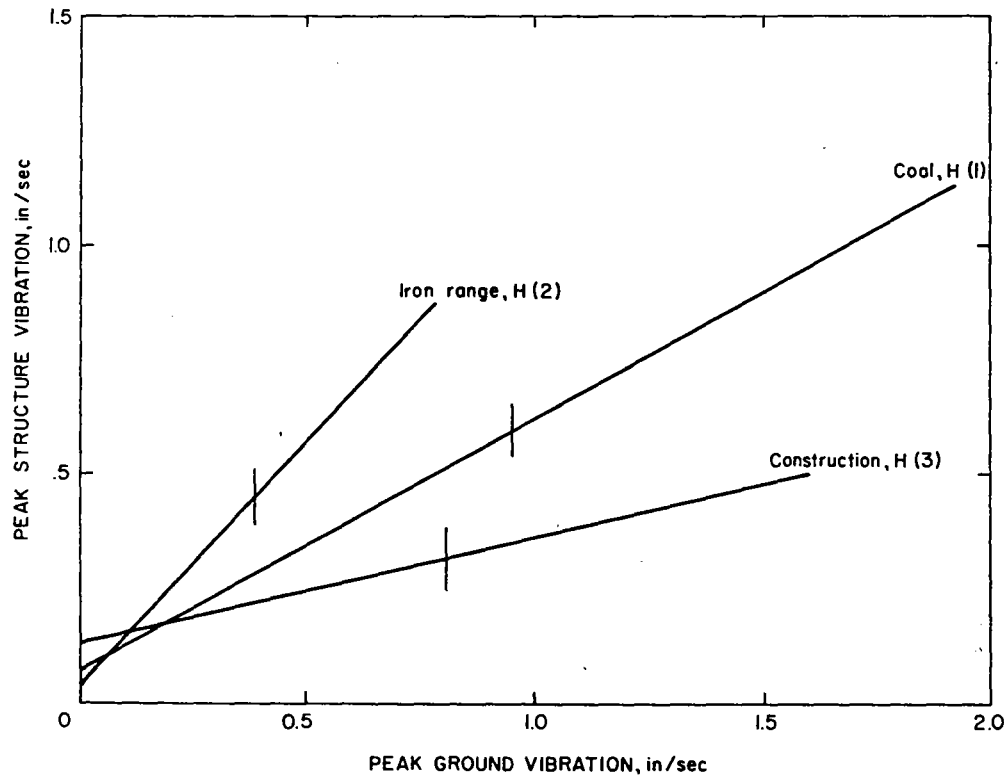

Figure 34.—Structure responses (corners) from peak horizontal ground vibrations, summary. Symbols, equations, and statistics are given in table 4.

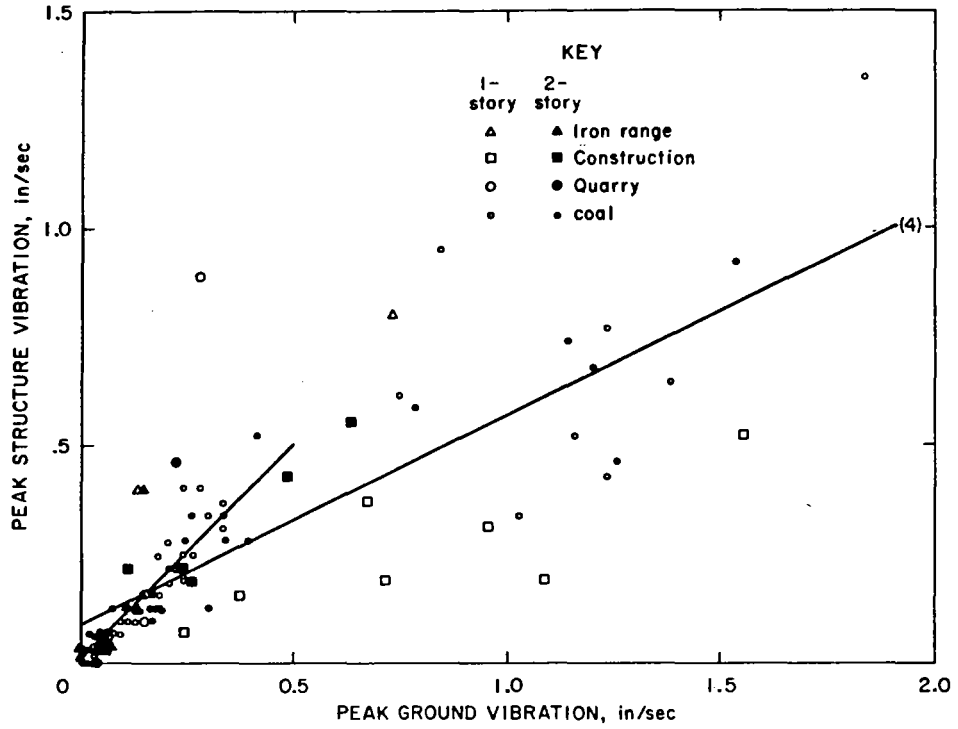

Figure 35.—Structure responses (corners) from peak horizontal ground vibrations with measured values. Equations and statistics are given in table 4.

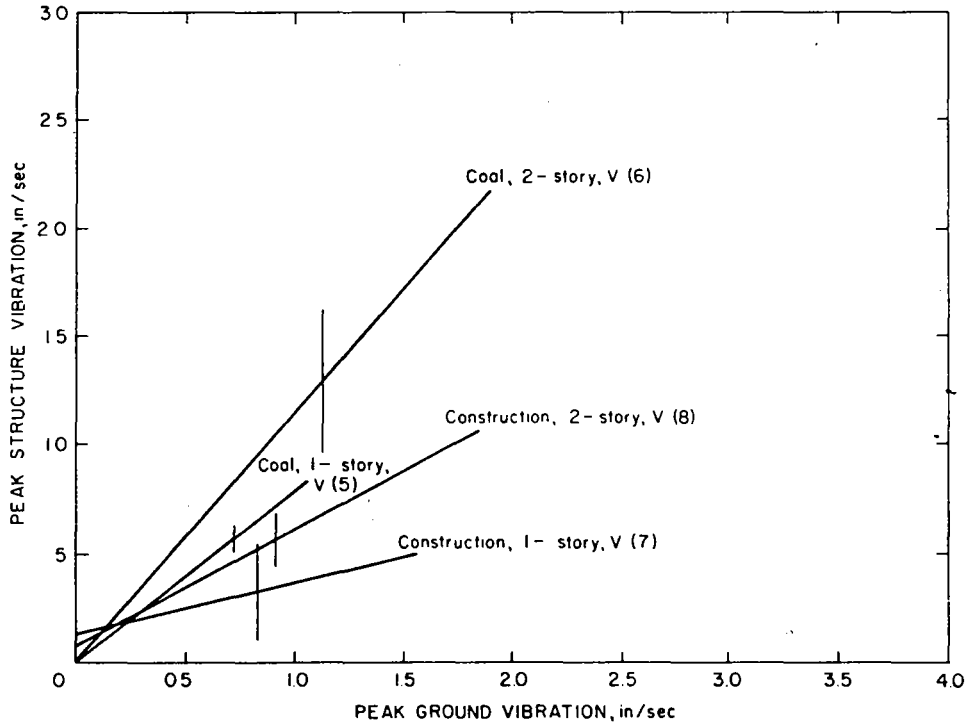

Figure 36.—Structure responses (corners) from peak vertical ground vibrations. Symbols, equations, and statistics are given in table 4.

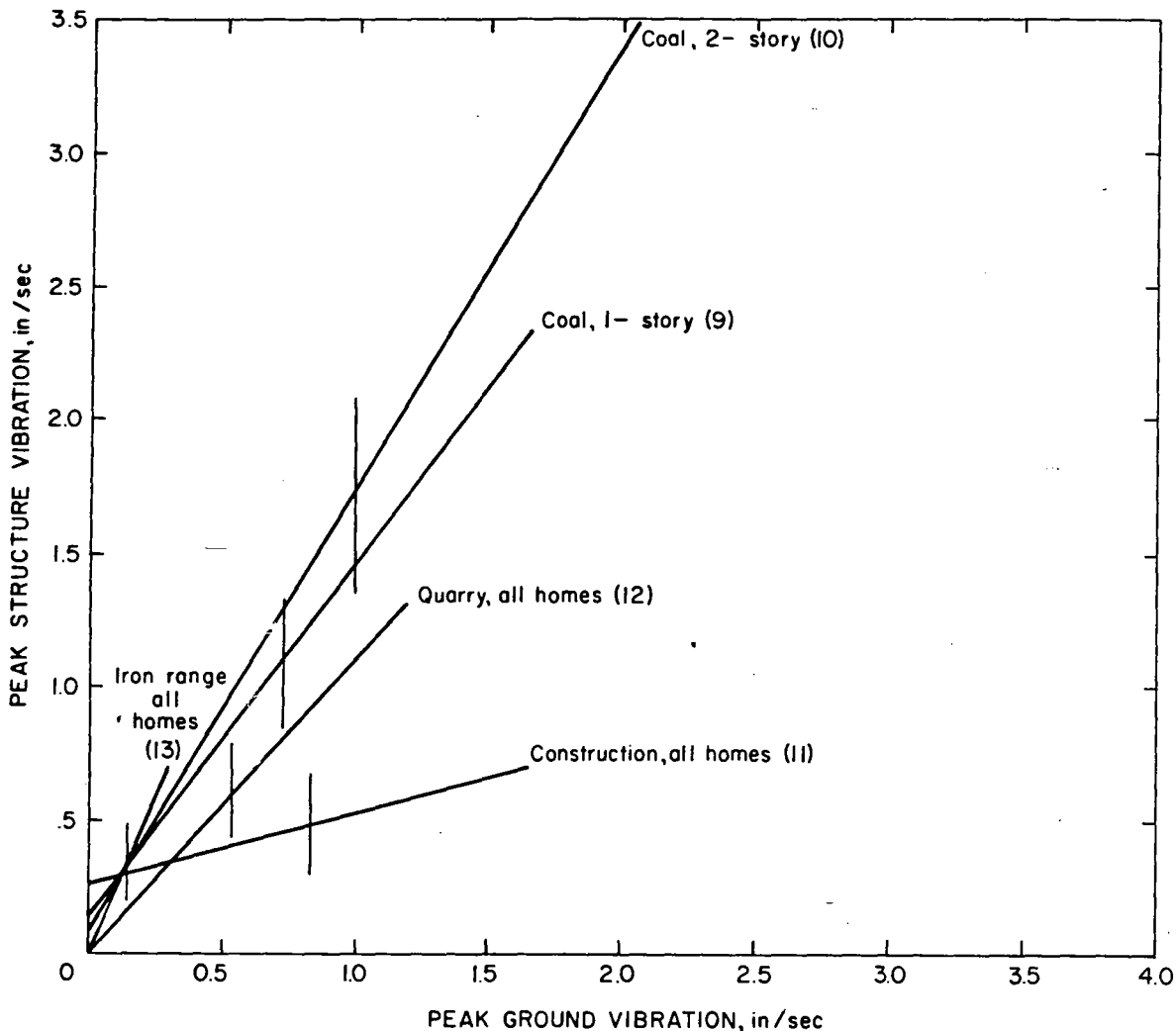

Figure 37.—Midwall responses from peak horizontal ground vibrations. Equations and statistics are given in table 4.

absolute, rather than relative, structure motions were measured, the responses at ground motion frequencies lower than the resonant frequencies theoretically should be unity; however, no ground motions with significant energy at frequencies lower than 5 Hz were encountered in this investigation. A summary of corner motion amplification factors for all of the homes studied is shown in figure 39. The highest amplifications were approximately 4, with 1.5 being a typical value. Ground motions above about 45 Hz produced little or no amplification of the corner-measured structure motion.

Midwall motion amplification factors are shown in figure 40. The maximum amplifications are greater than for the corners, with many responses occurring at higher frequencies, particularly up to 25 Hz. As with corner motions, amplification factors for ground motions above 45 Hz were less than unity.

These results suggest that frequencies below 10 Hz are most serious for potential damage from structure racking. Vibrations below about 25 Hz can excite high levels of midwall motion (typically wall motions are amplified 4 times that of the ground motions) and generate most of

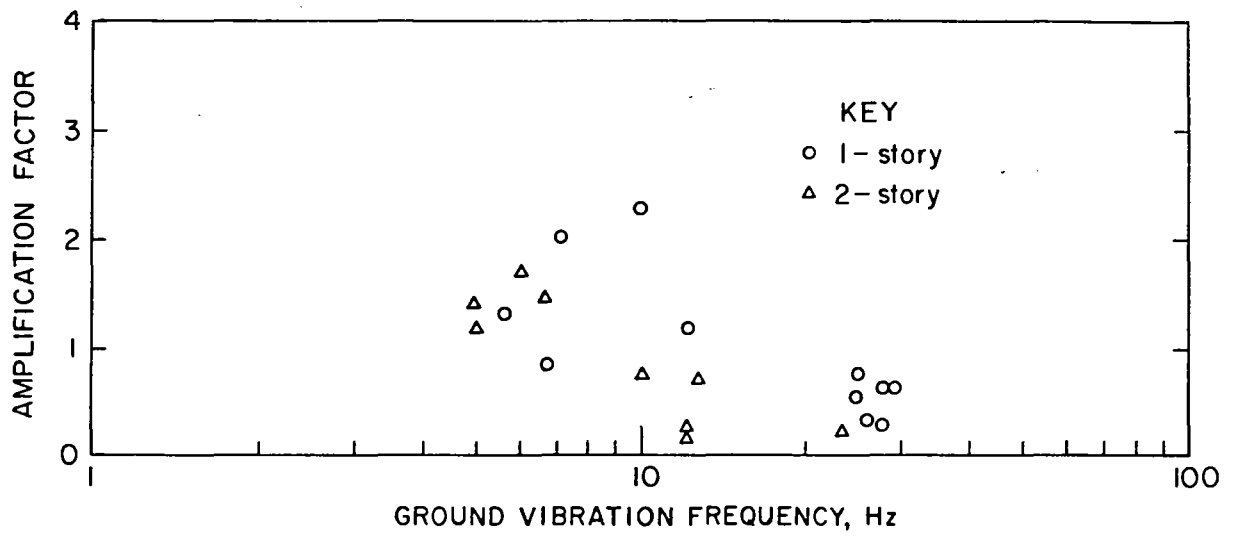

Figure 38.—Amplification factors for blast-produced structure vibration (corners) of a single 1-story and a single 2-story house.

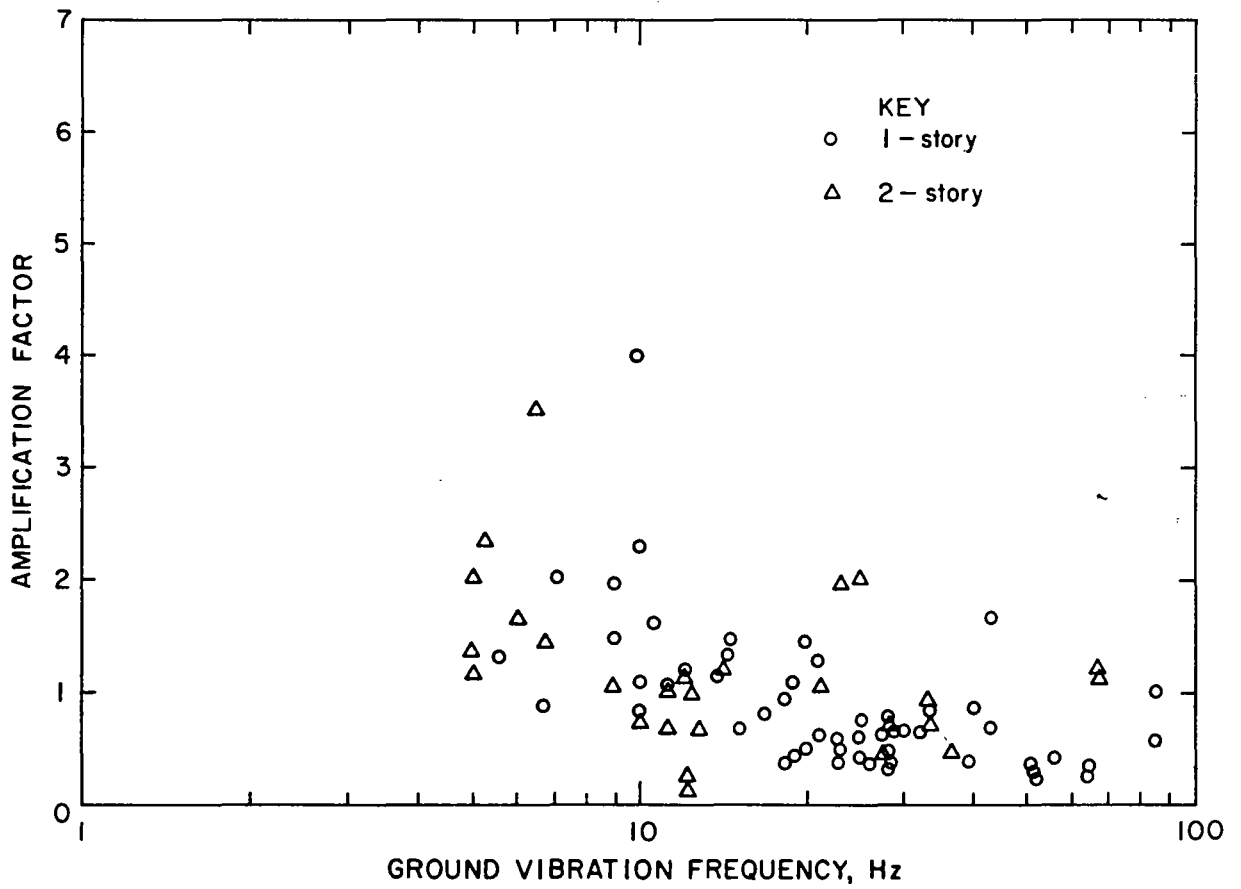

Figure 39.—Amplification factors for blast-produced structure vibration (corners), all homes.

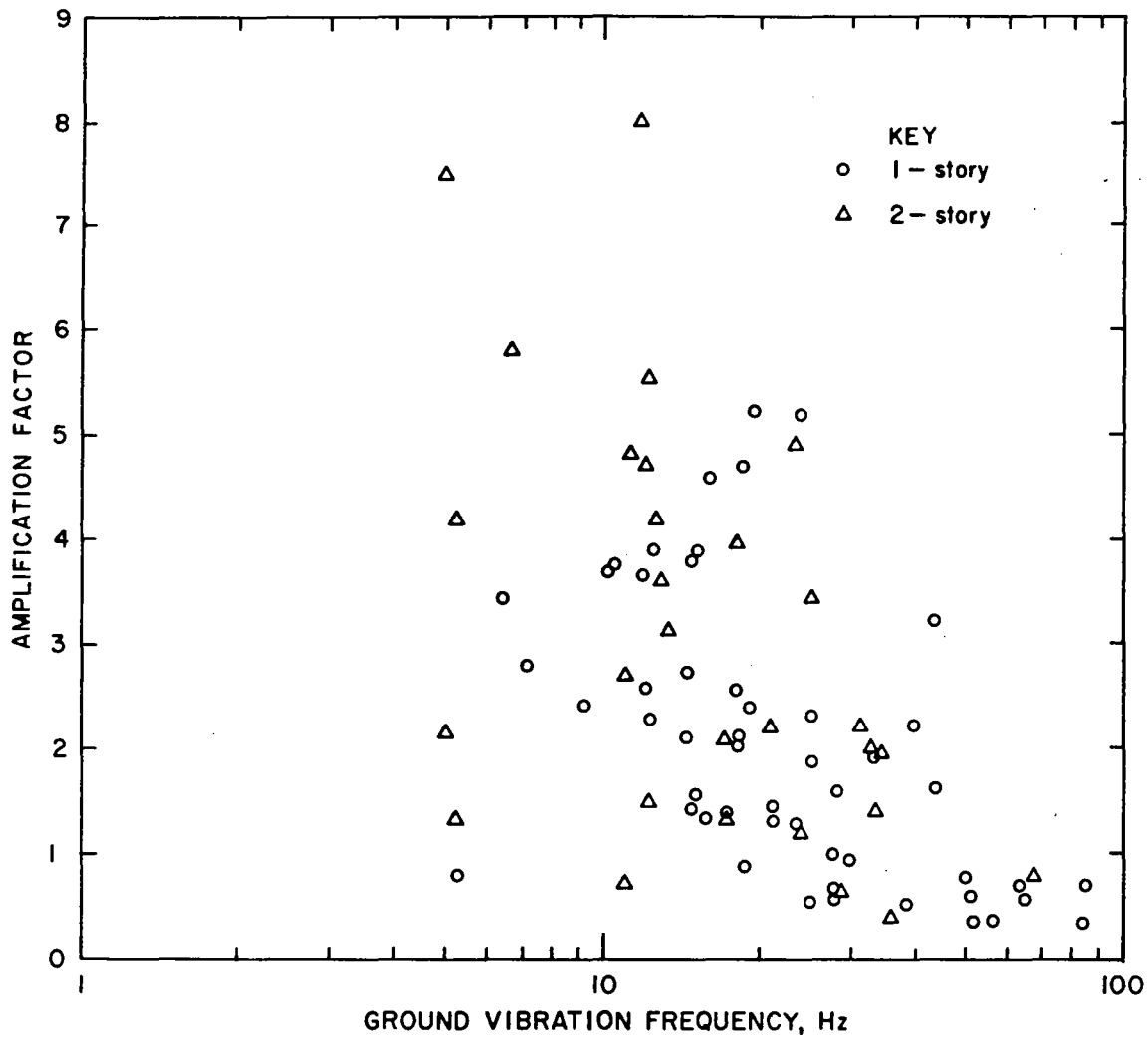

Figure 40.—Amplification factors for blast-produced midwall vibration, all homes.

the secondary noises, rattling, and other annoyances.

Kamperman studied transfer functions for residences subjected to quarry blasts (22). His concern was primarily with human response to midspan vertical floor motions, and an assess-

ment of various airblast measurement descriptors. Kamperman made 23 comparisons between measured outside ground and inside floor motions from 18 blasts. He found amplification factors of 1.60 for vertical peak particle velocity and 1.04 for horizontal velocity (lateral or radial).

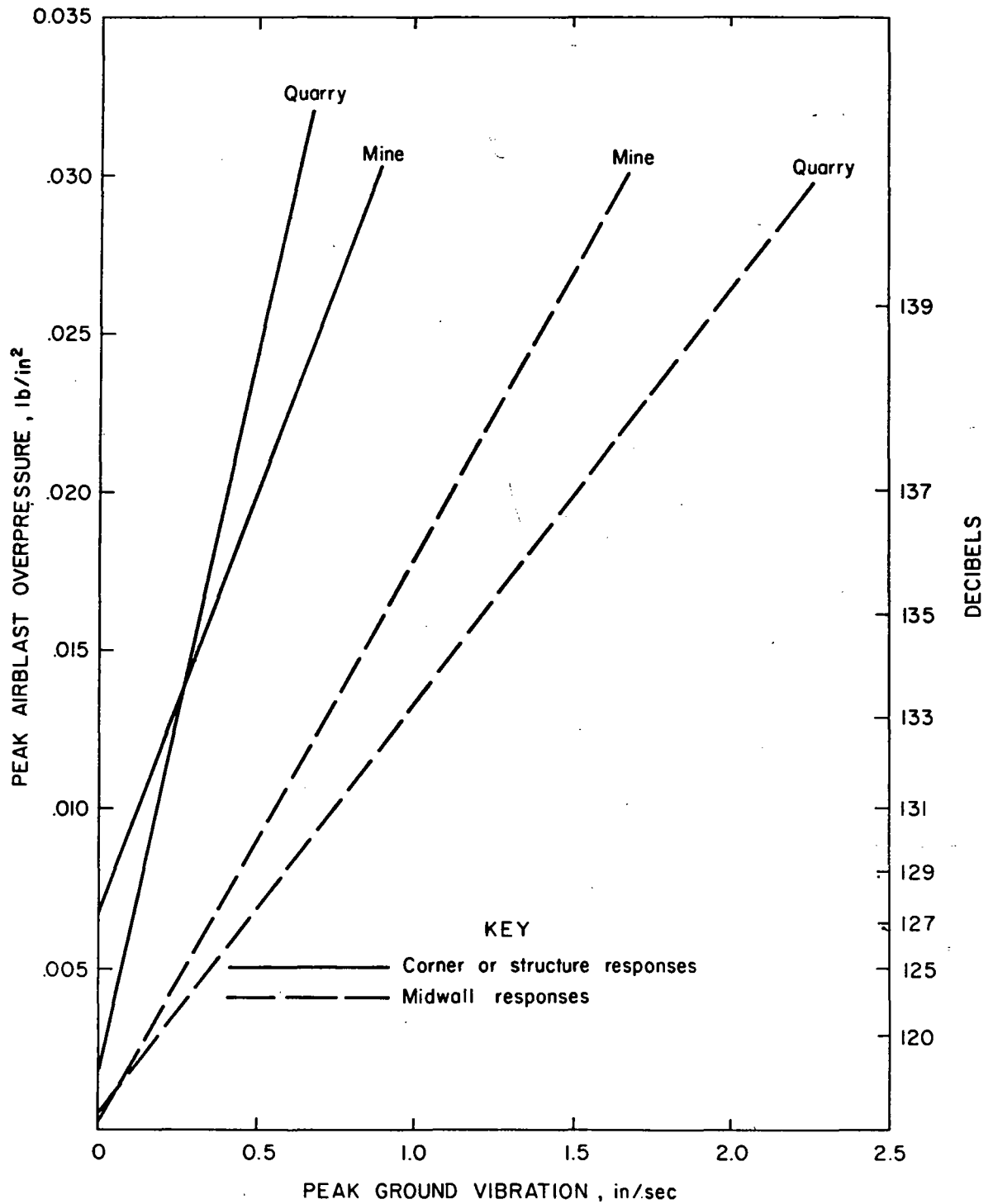

Figure 41.—Ground vibration and airblast that produce equivalent amounts of structure response, in frame residential structures of up to 2 stories.



Figure 42.—Test residential fatigue structure near surface coal mine. *ANRSHIAE*

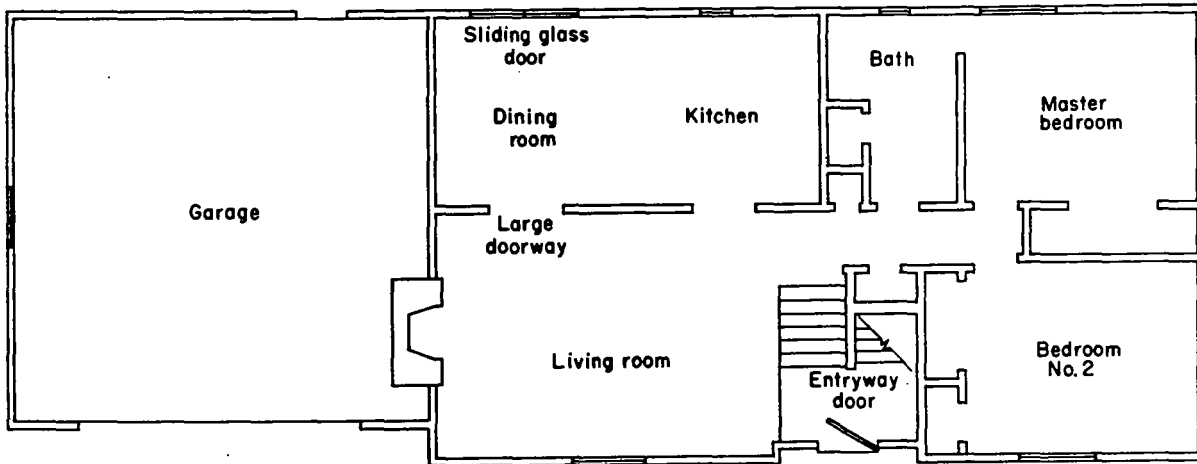

Figure 43.—Plan of main floor of test fatigue structure shown in figure 42.

Airblast Response

Structure responses from airblasts and sonic booms have been described in an extensive analysis of airblast from surface mine blasting (46). Levels of ground vibration and airblast that produce the equivalent structure motions are shown in figure 41, based on mean observed responses. The airblasts are those measured with 0.1-Hz low-frequency response systems. Typical 2- and 5-Hz commercial systems would give airblasts with sound levels in the range of 1 to 5 dB lower. Airblasts are relatively strong sources of midwall vibrations and poor sources of corner (whole-structure racking) vibration. The airblast levels producing the same amounts of corner vibration as 0.50 in/sec ground vibration are 0.020 to 0.024 lb/in² (137 to 138 dB). Relatively strong midwall vibrations are produced by airblasts, with only 0.007 to 0.009 lb/in² (128 to 130 dB) required to produce wall vibration equivalent to that from 0.50 in/sec ground vibration. From these equivalencies, airblast appears less likely to crack walls than ground vibration, as cracking occurs predominantly from shear and tensile wall strains that are produced by shearing rather than bending. Airblasts, however, are often responsible for the secondary rattling and annoyance effects produced by midwall motions (perpendicular to the planes of the wall surface).

Differences between mine and quarry blast-produced corner responses are not significant in the critical airblast range of 0.010 to 0.016 lb/in² (131 to 135 dB). By contrast, the midwall responses are very much different, probably because the relatively less confined quarry blasts produce more and higher frequency airblasts.

Structure Responses From Everyday Activities

Houses are subjected to a variety of vibrations and strains from human-produced transients and from slower processes of settlement from soil consolidation and changes in both the house and ground from natural environmental influences. The Bureau of Mines has measured strain and vibration from both human activities and from five mine blasts as the beginning of a study on fatigue effects in a residential structure.

The test structure and plan view are shown in figures 42 and 43. Strains were measured at critical places over windows and doorways using gages developed from a Northwestern University model (11). The maximums of the three strains measured at each location are given in table 5. The maximum principal strains would be slightly greater. Vibrations were measured in low and high corners, midfloors, and midwalls for both the blasts and the other activities (table 6).

Surprisingly high levels of strain and vibration were generated by the human activities. Comparisons between the blast- and human-produced effects suggests that house superstructures are continuously subjected to transients producing localized strains equivalent to ground vibrations of up to 0.50 in/sec. Additionally, it was found that effects produced in one part of the house (i.e., a front door slam) could produce significant strains all over the structure. No measurements have yet been made on the masonry facade or the basement floor or walls.

Table 5.—Strains in fatigue test structure from blasting and human activity

Strain locations	Maximum structure strains, $\mu\text{in/in}$						
	Mine blasts	Jumps	Heel drops	Door slams		Nail pounding	Walking
				Entrance	Sliding glass		
Over sliding glass door	¹ 22, ² 15	24	9.2	13	22	21	Low
Over south window in master bedroom	³ 18	42	20	12	19	9.3	9.1
Over large doorway in living room	⁴ 24, ⁵ 11	17	6.1	8.3	6.2	28	Low
Over picture window	⁴ 33	17	11	21	3.6	32	3.2
Over entrance door	⁴ 36, ⁵ 43	13	5.8	140	Low	Low	Low

¹ From peak ground vibration of 0.300 in/sec, 129 dB airblast.

² From peak ground vibration of 0.210 in/sec, 124 dB airblast.

³ From peak ground vibration of 0.290 in/sec, 124 dB airblast.

⁴ From peak ground vibration of 0.470 in/sec, 141 dB airblast. 119

⁵ From peak ground vibration of 0.320 in/sec, 125 dB airblast.

Table 6.—Structure vibrations in test fatigue structure from blasting and human activity

Vibration location	Mine blasts	Maximum structure vibrations, in/sec					
		Jumps	Heel drops	Door slams		Nail hammering	Walking
				Entrance	Sliding glass		
NW corner, low horizontal living room	¹ 0.472, ² 377 ² .483	0.190	0.055	0.220	0.110	0.100	0.056
NW corner, low vertical living room	—	.200	.069	.120	.041	.180	.180
NW corner, high horizontal living room	¹ .316 ² .345	.170	.037	.260	.100	.064	.054
SE corner, low horizontal master bedroom	³ .227 ⁴ .222	.310	.139	.182	.164	.508	.157
SE corner, low vertical master bedroom	³ .322, ³ 314 ⁵ .194	.286	.133	.121	.029	.118	.126
Midsouth wall, master bedroom	⁵ .508 ⁴ .700	1.44	.783	1.29	.136	.241	.225
Mideast wall, master bedroom	—	2.63	1.42	.934	.111	3.81	.285
Midwest wall, living room	¹ .964 ² 1.37	1.00	.486	1.05	.124	.365	.086
Midfloor, room	—	5.58	4.08	1.25	.031	.063	1.49
Midfloor, living room	¹ 1.18 ² .85	10.1	5.84	.453	.272	.067	.286

- ¹ From peak ground vibration of 0.470 in/sec, 117 dB airblast. 119
² From peak ground vibration of 0.320 in/sec, 125 dB airblast.
³ From peak ground vibration of 0.210 in/sec, 124 dB airblast.
⁴ From peak ground vibration of 0.300 in/sec, 129 dB airblast.
⁵ From peak ground vibration of 0.290 in/sec, 124 dB airblast.

FAILURE CHARACTERISTICS OF BUILDING MATERIALS

Most of the damage concern from the relatively low-level blasting vibrations involves cosmetic cracking of the interior walls of residences. Modern construction uses interior walls of gypsum plaster board (Drywall) with a covering of paint, wallpaper, or a plaster wash. Older homes often have interior walls of thick plaster over wood lath support. The strength of interior construction materials is not well understood, as they are not explicitly used as shear force resisting elements and homes tend to be nonengineered structures. However, it is evident that wall coverings stiffen their responses to forces acting in the planes of the walls. Early Bureau of Standards work on the strength of construction materials is discussed by Beck (3).

GYPSUM WALLBOARD FAILURE

Gypsum wallboard or Drywall consists of a panel of 3/8- to 5/8-in-thick gypsum plaster with a paper laminate covering on both sides. The 0.015-in-thick paper contributes greatly to the strength of the board and conceals cracking of the plaster core.

Strength tests on gypsum wallboard and plaster are summarized in table 7. Included are tests with and without paper laminates, preloaded static, and fatigue tests for various thicknesses of boards. Initial cracking could be seen on uncovered plaster but was masked by the laminate paper on covered wallboard.

Leigh studied plaster panels subjected to simulated sonic booms (28). In his fatigue study, he found only one failure out of 13 panels tested, and this he attributed to the experimental design. He also performed static failure tests.

Wiss measured strains on the walls of a home as part of his study of damage from blasting on the Mesabi Iron Range in Minnesota (57). His is the only failure strain measured under field blasting conditions. Wiss related his measured strains to peak ground particle velocities and found that 1.0 in/sec corresponded to interior strains of up to 50 $\mu\text{in/in}$, with 15 $\mu\text{in/in}$ being a typical value. Drywall failure strains were also determined from laboratory tests of samples removed from the structure. Failure strains were very high but compare well with results of Bureau of Mines tensile tests on Drywall sections.

Table 7.—Failure characteristics of plaster and gypsum wallboard

Author and type for failure ¹	Strain, $\mu\text{in/in}$	Stress, lb/in^2	Material	Thickness, in	Prestrain, $\mu\text{in/in}$	Cycles to failure
Leigh (28): Tensile	460	300	Plaster beam	NA	0	Static.
Do	365	300	Plaster panel	3/8	0	1
Do	260	200	do	3/8	0	10,000
Wiss and Nichols (57): Tensile	² 1,230	² 920	Gypsum wallboard with longitudinal section.	3/8	0	Static.
Do	³ 3,300	³ 1,460	do	3/8	0	Static.
Do	² 1,100	² 650	do	1/2	0	Static.
Do	⁴ 4,700	³ 1,100	do	1/2	0	Static.
Do	² 840	² 580	Gypsum wallboard with transverse section.	3/8	0	Static.
Do	³ 3,770	³ 785	do	3/8	0	Static.
Do	² 910	² 380	do	1/2	0	Static.
Do	² 400	² 580	do	1/2	0	Static.
Do (in situ)	1,162	NA	Gypsum wallboard	NA	NA	Blasting.
Dowding and Beck (11): Shear ⁴	130	NA	Gypsum wallboard core with paper laminate removed.	3/8	0	Static.
Do	80	NA	do	3/8	0	1,000
Do	50	NA	do	3/8	0	18,000
Do	90	NA	do	3/8	26	330
Do	76	NA	do	3/8	26	1,900
Do	56	NA	do	3/8	26	8,500
Do	² 340	NA	Gypsum wallboard	3/8	26	Static.
Do	³ >1,400	NA	do	3/8	0	Static.
Bureau of Mines (this study):						
Tensile	² 1,240	² 175	do	3/8	0	Static.
Do	³ 3,400	² 285	do	3/8	0	Static.
Do	² 1,420	² 170	do	1/2	0	Static.
Do	³ 3,210	² 250	do	1/2	0	Static.
Do	² 1,445	² 140	do	3/8	0	Static.
Do	³ 3,450	² 230	do	3/8	0	Static.
Shear	³ 3,000	² 95	do	1/2	0	Static.
Do	³ 8,450	³ 136	do	1/2	0	Static.

NA = Not available.
¹ All laboratory tests except as noted in parentheses.
² Initial gypsum core failure.
³ Ultimate failure, paper laminate damage.
⁴ Beck's strains involved measurement on test sample. Others used platen displacement.

Beck sheared gypsum panels to failure, while investigating both fatigue behavior and the effects of preloading (3, 11). Most of his tests were on commercially cast panels from which the paper laminate had been removed. He found that after 5,000 cycles the panel would fail at about half the maximum strain that corresponds to static failure. Beck also found that preloading or prestraining reduced the number of cycles required for failure and also the failure strain.

The principal failure strains for this study and the two points from Wiss' study are plotted in figure 44, along with observed static failure levels. Large variances are shown for Drywall core failures (e.g., 340 to 1,200 $\mu\text{in/in}$), which can be attributed to experimental load setup, moisture differences, and method of strain determination. Additional fatigue testing of building materials is needed.

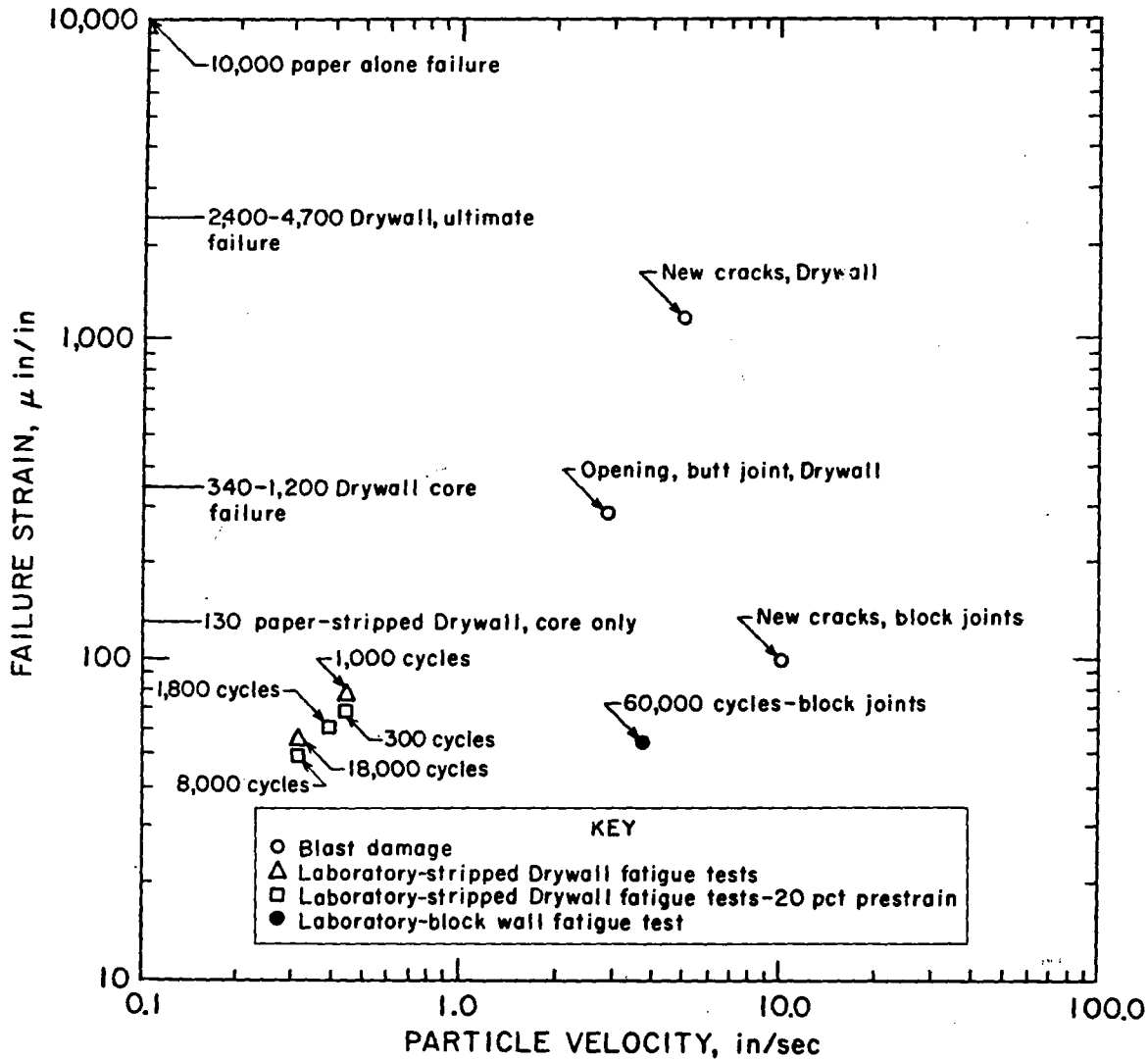

Figure 44.—Failure strains for residential construction materials from a variety of sources (tables 7 and 8).

The ultimate tensile failure strain for typical gypsum wallboard appears to be about 1,000 $\mu\text{in/in}$ (57). Assuming that a stress concentration of 10 corresponds to the space above doorways or large windows, a shear deformation producing a uniform 100 $\mu\text{in/in}$ would be potentially damaging. Projecting this over a typical house wall length (30 ft) gives peak differential displacements of approximately 0.036 in.

Complicating comparisons between different studies is that some measurements are made directly on the test specimens, while others are made using the machine platens. These values can differ by a wide margin.

MASONRY AND CONCRETE FAILURE

The two Canadian studies of blasting vibration damage included measurements of strains in basement walls of thick stone and mortar (table 8). Edwards and Northwood (16) found dynamic strains corresponding to initial cracking of $> 375 \mu\text{in/in}$ and permanent induced strains of $> 150 \mu\text{in/in}$. Later measurements by Northwood found very much lower cracking thresholds of 45 $\mu\text{in/in}$ (38).

Crawford and Ward studied masonry cracking induced by blasts in an 8- by 8-foot block and poured concrete box filled with sand (9). They found that poured concrete walls were much stronger than block walls and required high levels of both strain and particle velocity to induce cracking. The mortar joints of the concrete block wall failed at considerably lower strains, but the blocks themselves had the same ratio of strain to velocity as the concrete walls. The walls of concrete block and mortar did not act as monolithic bodies but as concentrated

strains at the mortar joints. Crawford and Ward measured strain levels across the mortar joints that were 10 times those on the adjacent blocks (9).

Cracks appeared in the mortar joints when strains of 30 $\mu\text{in/in}$ were measured on the blocks, consistent with Northwood's values (38). The strains across the joints were 300 $\mu\text{in/in}$. These results are consistent with the observations that cracks in the mortar between the blocks or bricks are the first signs of damage in masonry. Crawford and Ward recommended particle velocity as an index of damage independent of masonry type, with failure at 3 in/sec measured radially to the blasting and perpendicular to the block surface. This corresponds to surface strains of 35 to 40 $\mu\text{in/in}$ on the blocks. Monolithic concrete, on the other hand, did not crack until particle velocities exceeded 10 in/sec and strains of 100 $\mu\text{in/in}$. Even then, the concrete cracked at the corners of the box. This location of cracking suggests that expanding gas pressures may have deformed the box and cracked the concrete at strain concentrations in the corners.

The measurement of strain is a useful engineering tool. It may provide the most appropriate method of assessing cracking potential for instances where locations of maximum strains can be predicted beforehand and material failure characteristics are understood.

FATIGUE

A very limited amount of work has been done on fatigue or damage from long-term repeated blasting. For engineered materials, fatigue strengths are typically a significant fraction of the ultimate strengths (e.g., 50 pct).

The U.S. Army Corps of Engineers, Civil Engineering Research Laboratory (CERL), conducted a fatigue damage test for the Bureau of Mines as the first phase of a full-scale fatigue study (54). An 8-foot-square by 8-foot-high test structure (model room) was built on the CERL 12- by 12-foot biaxial vibration table (fig. 45). This structure represented a typical residential room with a 7-foot doorway and two window openings. It was constructed of 2- by 4-inch wood studs and $\frac{3}{8}$ -inch-thick gypsum wallboard. Joints were taped and finished in the standard manner, with metal beads on the outside corners.

The vibration simulator that shook the base was programed with one of the horizontal components and the vertical component of an actual

Table 8.—Failure of masonry and concrete

Author and type of material	Dynamic strain at failure, $\mu\text{in/in}$	Particle velocity, in/sec	Type of cracking
Edwards and Northwood (16): On stone mortar basement walls, 18 to 24 in thick	375	3.1	Threshold.
Do	150	3.1	Do.
Northwood, Crawford, and Ed- wards (38): On stone and mor- tar walls perpendicular to shot (radial)	40	3.4	None.
Do	45	4.5	Threshold.
Do	75	7	Minor.
Do	80	10	Major.
Crawford and Ward (9): 8- and 10-in concrete block	30	3	Threshold.
Mortar joints	300	NAP	Do.
7- and 9-in poured concrete	100	10	Do.

NAP = Not applicable.

¹ This is permanent strain. All the remaining are dynamic.

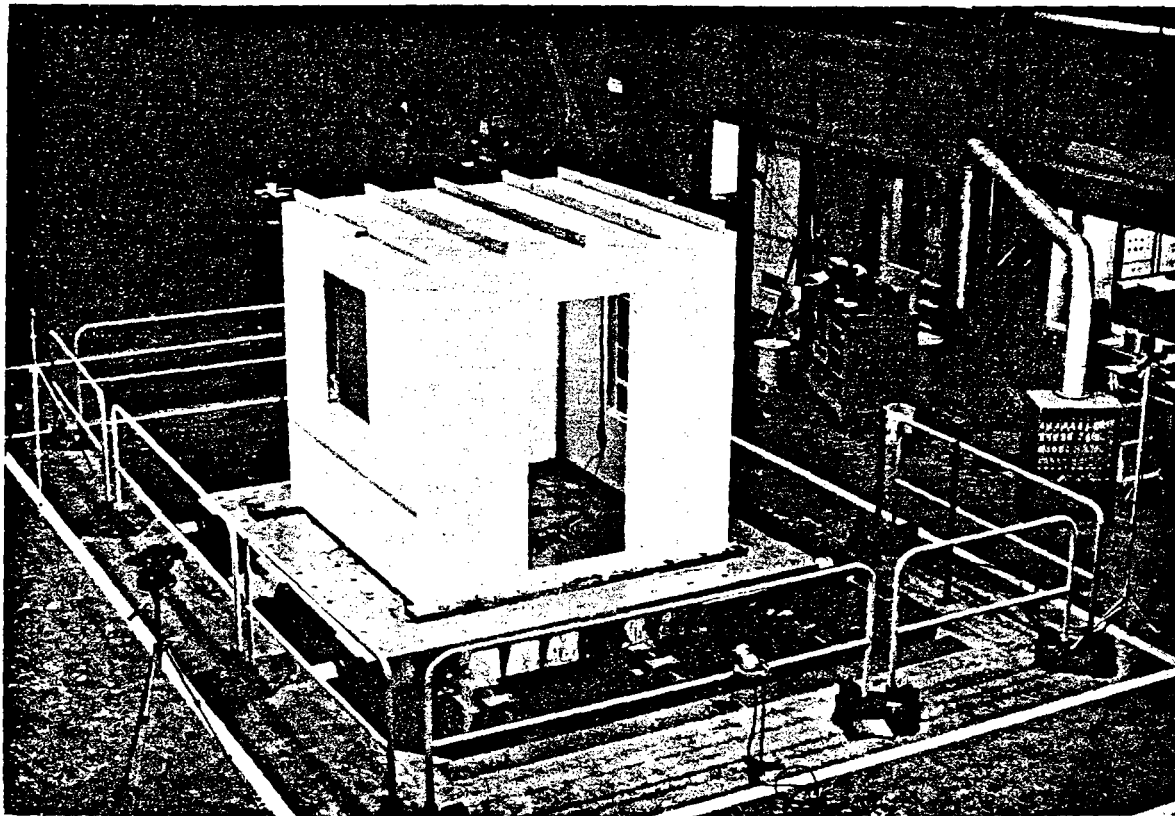

Figure 45.—Fatigue test model on biaxial vibrating table.

quarry blast from Bulletin 656 (37). The predominant horizontal and vertical component frequencies were 26 and 30 Hz, respectively. Testing consisted of a series of "blasts" at increasing platform vibration levels with inspections between each series. The sequence of number of events for each level of vibration was 1, 5, 10, 50, 100, and 500. The vibration levels run were 0.1, 0.5, 1.0, 2.0, 4.0, 8.0, and 16.0 in/sec. The first damage was observed after six events (blasts) at 4.0 in/sec, when the Drywall pulled away from the bottom plate. After six events at 8.0 in/sec nails began to work out, and after 66 events the corners cracked. A level of 16 in/sec produced cracks at window openings. The vibration levels from this study cannot be directly related to the full-scale case, because the excitation motions were not scaled (e.g., the natural frequency of the model was too high because the mass was too low). However, the existence of fatigue was demonstrated as each new degree of damage was observed after several complete events at that vibration level.

Fatigue and cracking of masonry walls have been studied by Koerner (23). He subjected $\frac{1}{10}$ -scale block masonry walls to sinusoidal vibrations at their resonant frequencies of 40 to 50 Hz. Failure was observed after approximately 10,000 cycles at peak particle velocities of 1.2 to 2.0 in/sec. More cycles were required for damage at frequencies outside of resonance. Recent tests by Koerner on $\frac{1}{4}$ -scale block walls also found fatigue effects, including the cracking of three walls at particle velocities of 1.69 to 1.95 in/sec, requiring 60,000 to 400,000 vibration cycles. Koerner predicted that the prototype natural frequency values would be half those of his model walls, and that the failure particle velocities would then be double the model results (23). Applied to full scale, these results correspond to more than a thousand 1-sec-long, 40-Hz events. In addition to Koerner's study, other fatigue studies are in progress to quantify the failure potentials from long-term blasting as well as the other stress-producing environmental factors.

SAFE VIBRATION LEVELS FOR RESIDENTIAL STRUCTURES

There are a large number of publications on ground vibrations and blasting; however, few contain actual observations of damage⁷ and corresponding measurements of ground motions. In 1962, the Bureau of Mines published RI 5968 by Duvall and Fogelson (14). This was a summary analysis of the three existing blasting damage studies, one from Canada (16), one from Sweden (26), and data from Bureau of Mines Bulletin 442 dating back to 1942 (51). RI 5968 was revolutionary in several respects. It recommended the use of a single motion descriptor, particle velocity, in place of displacement and acceleration. Based on the use of particle velocity, a single safe value damage criterion of 2.0 in/sec was recommended, which was frequency independent over the wide range of 2.5 to over 400 Hz.

In 1971, the Bureau of Mines published Bulletin 656, a comprehensive summary of the many problems of blasting, including generation, propagation, and damage from both ground vibration and airblast (37). The ground vibration damage data in Bulletin 656 were those collected for RI 5968. A single new point from a study by Wiss (57) was included, but no new statistical analysis was conducted to include studies made since the 1962 report. It later became evident that the Bureau-recommended vibration criterion was not applicable under some conditions and that damage was occurring below 2 in/sec. Consequently, in 1974 the Bureau of Mines started a new program to examine damage from blasting. This included an analysis of data that had become available since 1962, and also the collection of new damage data, particularly from large-scale blasting operations in coal mines.

- Review of the RI 5968 indicated that low-frequency vibrations (e.g., 2.5 to 40 Hz) were a significant problem and required additional study, such as response spectrum analysis. The 2.0-in/sec safe level had been based on a mixture of both high- and low-frequency damage data. Consequently, the inferred 5-pct damage probability was somewhat artificial and depended on the relative amount of each kind of data avail-

able. Using any given number of standard deviations from the mean of the high- and low-frequency data separately would give widely differing safe values for the two cases. The derivation of 2.0 in/sec as the safe level was based on 2.0 standard deviations from the 5.4-in/sec mean of all the minor damage points. Five values for minor damage were outside the 2.0 standard deviation damage envelope (at approximately 1.2, 1.36, 1.24, 0.75, and 0.32 in/sec), all from Bureau of Mines shaker tests that only approximately modeled transient blast loads (51). The last of these values was dropped for statistical reasons. Because 2.0 in/sec was also lower than all the individual major damage points, and because it included all actual blasting damage data, it was recommended as a boundary between damage and nondamage.

The large amount of scatter in the summary analysis at low frequencies is undoubtedly caused by the presence of structure resonances and initial strain states. The lower frequency vibrations also result in large displacements (and strains), and it is strain that ultimately produces cracking. RI 5968 had not presented sufficient data for separate analyses of the low and high frequencies because it was based upon only three studies, one of which was not blasting. Since the 1962 report, four major sets of additional data have become available, including new damage data obtained from Bureau of Mines research. Three other studies have supplied a few new damage points each, bringing the total number of relevant studies to 10 (table 9). Direct statistical treatment of the type used in RI 5968, probability analysis, and response spectra analysis were all applied to quantify blasting damage potentials.

PREVIOUS DAMAGE STUDIES

Few studies have been made that actually produced data useful for determination of thresholds and probabilities of damage. Required are actual structures near enough to blasts for damage and careful preblast and postblast inspections. All homes are cracked from natural causes, including settlement and periodic changes of humidity, temperature, and wind. Soil moisture changes are notorious for causing foundation cracks (e.g., from tree roots). The widths of old cracks change seasonally and often daily; however, the number of cracks continues to increase with age, independent of blasting.

⁷ The term "damage" is used in this report and those referenced (14, 16, 26, 37, 51) to refer to cracking of either interior superstructure walls or masonry. The special nature of the damage is discussed in later sections of this report (and in table 10); however, it is understood that the observed damage refers to cosmetic and superficial effects, and that the structural integrity of the homes is not being questioned here.

Table 9.—Studies of damage to residences from blasting vibrations

Study	Damage classifications	Types of damage	Overburden type	Structures studied	Distances to shots, ft	Shot sizes, lb/delay	Frequency range, Hz	Total shots	Damage observed, uniform classification				Instrumentation
									Non-damage	Threshold	Minor	Major	
Thoenen and Windes, Bureau of Mines (51).	Threshold and minor.	Plaster cracks and fall of plaster.	None	6 frame, brick, and stone, 1 to 3 story.	None	None	4-40	163	103	26	34	0	Displacement.
Langefors, Westberg, and Kihlstrom (26).	Minor and major. do	Rock	NA	NA	NA ²	48-420	105	57	0	32	16	NA.
Edwards and Northwood (16).	Threshold, minor, and major.	Cracks in masonry, bricks, or stone basement walls.	Soft, wet sand with clay 20 ft down, and well-consolidated glacial till.	6 total: 4 with 12-in brick and plaster interiors, 2 frame.	30-200	47-750	2.5-25	22	22	6	8	5	Displacement and acceleration measured on basement walls.
Northwood, Crawford, and Edwards (38). do	Basement wall damage close in, and super-structure plus basement damage far out.	Glacial till and limestone overlain by thin till layer.	6 total: 1 frame, 1 stone, 4 9- to 12-in brick.	3-300	0.3-1,600	37-120	60	51	10	4	5	Velocity, MB-120 gage, measured on basement walls.
Thoenen and Windes, Bureau of Mines (51).	Threshold and minor.	None	10 quarries	14 total	715-2,500	36-1,200	3-16	43	11	0	0	0	Displacement and acceleration.
Morris and Westwater (31).	Threshold	Plaster and partition cracks.	1 quarry and 1 surface coal mine.	2 stone with plaster interiors.	115-820	200-14,000	3.7-5.7	3	1	2	0	0	Displacement.
Dvorak (15)	Threshold, minor, and major.	Plaster and masonry cracks.	Semihard clay with sand lenses.	4 brick and masonry.	30-164	2.2-44	1.5-15	58	7	25	15	11	Do.
Wiss and Nicholls (37).	Minor	Drywall cracks ..	Glacial till	Single structure, rubble stone foundation.	35-200	1-85	NA	10	9	0	1	0	Velocity, MB-120 gage.
Jensen and Rietman (37). 2) do do	Rock with 0 to 7 ft of soil overburden.	18 frame structures.	130-185	1.75-12.75	311-126	29	27	0	2	0	Do.
Bureau of Mines new data.	Threshold and minor.	Plaster, Drywall, and masonry cracks.	Various, usually with soil overburdens.	17 frame structures.	14-2,500	18-2,600	6.3-71	225	ST 76	28 38	3	0	Do.

¹ Shaker tests.² Excavation in rock, small shots.³ Predominantly 12 to 26 Hz for damage data.⁴ Plus 1 at 5 ft.⁵ Mostly >30 Hz.

NA = Not available.

Analysis of damage probabilities is particularly difficult because of the low probabilities being sought. For example, reliable determination of the 2-pct damage probability theoretically requires 49 nondamage measurements for every one of damage. Consequently, it is necessary to pool all the available data while avoiding the use of data that are clearly not similar to actual blasting. Examples of the latter are teleseismic blast vibrations and earthquakes, whose low-frequency content and long durations make them more likely to produce damage to structures. Thoenen and Windes' (51) early analyses recognized the nonapplicability of the Mercalli intensity scale developed for earthquakes, and Richter's observations on duration effects were discussed in the section on ground vibration characteristics. The shaker damage results of Thoenen and Windes are also questionably applicable, being of longer duration than actual blasting.

All the applicable blast-vibration damage studies are summarized in table 9, all involving preblast and postblast inspections. A detailed analysis of these studies is not made in this paper. Many are discussed in Bulletin 656 (37), and only the last two represent entirely new data. The first three studies in the table had been analyzed in RI 5968; summary results are in figure 3.4 of Bulletin 656 and figure 6 of RI 5968 (14). In some cases, measurements were made on foundation walls, and in others in the ground next to the structure. Obviously, uniform measurements are highly desirable. Stagg (50) discusses measurement methodology. The degrees of damage (threshold, minor, and major) are given in table 10.

The Canadian researchers made the second study of damage from blasting (38) published after RI 5968. This followed the Edwards and Northwood investigation (16), involved more shots and a wider range of both shot-to-house distances and shot sizes, and utilized similar experimental design.

Thoenen and Windes reported on a series of quarry blasts intended to study damage to residences (51). In the absence of damage, they used structure vibrators to induce cracking. The quarry nondamage data were not useful in the mean square analyses of damage thresholds performed for RI 5968; however, they are useful for probability analysis where numbers of damage and nondamage observations are compared.

Morris and Westwater described early studies on blast damage at a time when all measurements and damage criteria were based on ground displacements (31). In addition to discussing the Thoenen and Windes study, they describe three monitored blasts in Britain where inspections were made. They concluded that 0.040-in peak displacement would be a safe value criterion, and that a previously recommended maximum of 0.008 in had a considerable margin of safety. The damage data all involved low frequencies (3.7 to 5.7 Hz) with the 0.040-in displacement corresponding to a 1.0 in/sec particle velocity at 4 Hz, assuming simple harmonic motion. Prior to the use of particle velocity and going back to 1947, the State of Pennsylvania had a maximum safe blasting criterion of 0.030-in peak displacement for vibration frequencies below 10 Hz (27).

Dvorak (15) examined damage to masonry residences in a study published soon after RI 5968. Bulletin 656 discusses the Dvorak study, but did not include it in the summary analysis. The Bulletin raised questions about the old instrumentation used by Dvorak. It is not possible to verify the reliability or accuracy of any of the old studies, particularly those that published few of their actual data and for which the original time histories have been lost.

Recognizing the problems caused by old instrumentation, and particularly the low levels of damage observed by Dvorak, the analyses for this study were run both with and without the Dvorak data.

Table 10.—Damage classification

Uniform classification	Description of damage	Studies of blasting damage
Threshold	Loosening of paint; small plaster cracks at joints between construction elements; lengthening of old cracks.	Threshold: Dvorak (15); Edwards and Northwood (16); Northwood, Crawford, and Edwards (38). Minor: Thoenen and Windes (51).
Minor	Loosening and falling of plaster; cracks in masonry around openings near partitions; hairline to 3-mm cracks (0 to 1/8 in.); fall of loose mortar.	Minor: Dvorak (15); Edwards and Northwood (16); Northwood, Crawford, and Edwards (38); Jensen and Rietman (21); Langefors, Westberg, and Kihlstrom (26). Major: Thoenen and Windes (51).
Major	Cracks of several mm in walls; rupture of opening vaults; structural weakening; fall of masonry, e.g., chimneys; load support ability affected.	Major: Dvorak (15); Edwards and Northwood (16); Northwood, Crawford, and Edwards (38); Langefors, Westberg, and Kihlstrom (26).

Wiss and Nicholls (57) examined the blast damage characteristics of a single well-constructed residence on a soil type similar to that of the Canadian studies (16, 38). Their single damage observation was from a very high particle velocity for this damage-resistant, rubble-stone foundation structure with gypsum Dry-wall. This point was shown in the Summary of Bulletin 656 (37, fig. 3.8) for comparison to the other three studies.

Jensen and Rietman measured vibration effects from construction blasts for the Bureau of Mines (21). The goal was to collect response data for residences from small-scale excavation blasting for comparisons of the relative responses from shots of widely differing frequency character. Damage observations were also made, and the resulting values were used in this study. One shot was so close to the foundation (5 ft) that damage was caused by permanent ground strain, or inelastic effects. This value was not used in the analyses.

Two recent studies in Sweden became available too late for the analyses in this paper (4, 6). They involved structures on solid rock, and their damage observations agreed with previous Swedish results (26). Bergling described a test of blast damage to a concrete and brick residence (4). Shots were in the range of 1 to 50 m distance, and the lowest level at which damage was observed was 110 mm/sec (4.33 in/sec). Bergling also discussed the strict German DIN 4150 Standards and British 117 (1970) Standards (appendix A). Bogdanoff described a house of similar construction, also directly founded on granite-gneiss bedrock (6). From 38 rounds at distances less than 100 m, he indicated no damage below a vertical peak particle velocity of 90 mm/sec. They concluded that 30 mm/sec was safe for this structure (and geology), since many nondamaging shots occurred at this level.

The Salmon nuclear blast generated damage and complaint data (39), as well as the structural responses discussed previously (5). The damage observed was at large distances and occurred at lower levels than those observed for blasting. Particle velocity was estimated to have been approximately 5 mm/sec in Hattiesburg, 34 km away from the blast. Complaints about damage were also very high, with 1 pct of all families complaining at particle velocities of 2 mm/sec (0.08 in/sec), and 10 pct at 10 mm/sec (0.40 in/sec). Little justification exists to applying the Salmon results to typical mine blasting. As discussed in the section on Ground Vibration Char-

acteristics, the 90-sec-long, low-frequency wave is far more typical of earthquake ground motions than of blasting. As no preblast surveys were available, damage causation was impossible to determine.

J. F. Wall studied masonry structures in Mercury, Nev. (53). He tabulated rates of cracking and concluded that they were higher during times of blasting. He concluded that the nuclear blasts at 33 to 78 km, which produced peak particle velocities of 1 to 3 mm/sec, were generating 4 to 30 cracks in concrete block structures over the natural rate of 2.5 cracks/day (for all 43 structures). As in the Salmon study, there were no direct damage observations that could be attributed to the specific events. Also, as in the Salmon study, the vibration time histories were of character similar to teleseismic vibrations; that is, dispersed to long durations and dominated by low-frequency surface waves. Even if the damage observed were caused by the nuclear blasts, it provides no reliable insight into damage potentials from conventional blasts. Nelson (36) monitored crack widths in six of the Mercury structures. He observed that crack width changes during intervening periods (from wind, temperature, sun, and humidity variations) were larger than those attributed to the seismic events.

The Rulison 40-kiloton nuclear shot also provided damage data where the event durations (of 5.5 to 7 sec) were somewhat typical of mine or quarry blasting (43). Frequencies were probably again very low because of the long absolute distances. As with the other nuclear blast studies, no preblast inspections had been made and crack observations were based on postblast evaluations. Scholl's survey of five nearby towns found damage ratios of 3 to 6 pct at peak particle velocities of 0.79 to 1.07 in/sec, based only on postblast inspections. This is in fair agreement with the Bureau of Mines summary blast damage results discussed later in this report.

Scholl also studied the Handley nuclear blast and other similar events for complaints and damage (42). He related pseudo absolute accelerations and complaint ratios for these events of very low frequency ground motion, in the range of 0.25 to 1.5 Hz. No determinations were made of damage claim validity.

Esteves describes damage to a single concrete and tile residence near a quarry (17). The first damage observed was plaster cracks at 60 mm/sec (2.35 in/sec).

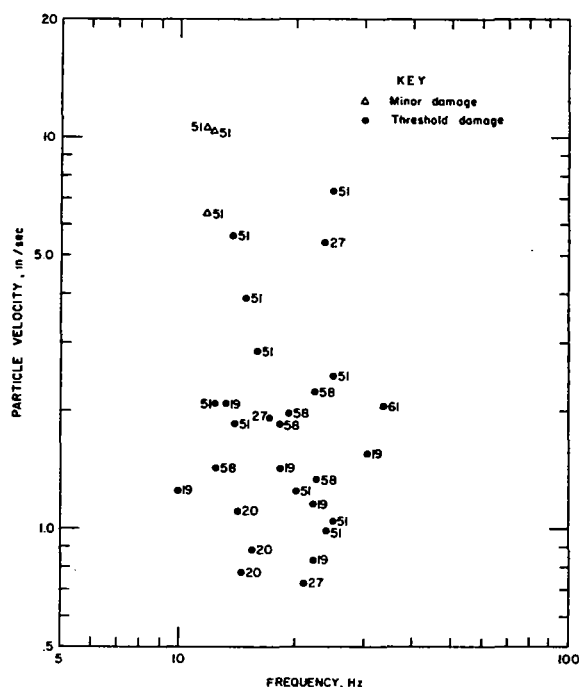

Figure 46.—Damage observations, new Bureau of Mines data from production blasting in surface mines. (Houses are listed by number in table 3.)

NEW BUREAU OF MINES DAMAGE STUDIES

The Bureau conducted a series of field studies of ground vibration and airblast damage and responses from 1976 to 1979. Efforts were concentrated on actual measurements of wall, floor, and racking responses and the observations of damage that could be correlated to specific vibration events. A significant part of the work was done near large surface coal mines, with thick soil overburdens and large-diameter blast-holes; cases of this sort had not been studied previously.

The production shots monitored for the damage analysis are listed in table 1. At five sites, houses were in the paths of the advancing mines and eventual damage was inevitable. Most of the homes, however, were not owned by the mines, and the blasts had been designed to protect them from damage. In all, 63 shots out of 225 produced useful high-level damage and nondamage data. Most of the other shots provided data on structural responses and airblast effects. Thirty-two of the shots (labeled "W" in table 1) were measured by Jensen and Rietman (21) under a Bureau of Mines contract. A total of 76

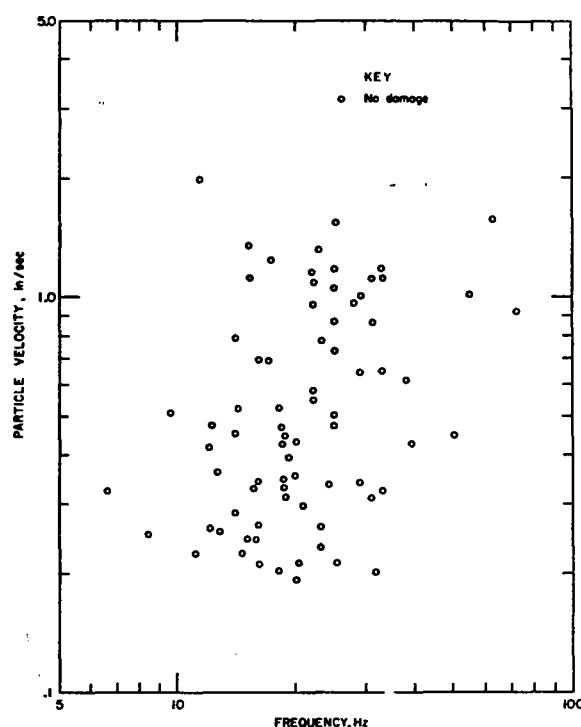

Figure 47.—Nondamage observations, new Bureau of Mines data from surface mine blasting.

houses were studied (including 18 by Jensen and Rietman) and are listed in table 3. The houses that were subjected to high ground vibration levels and produced useful damage data are shown in figures 15–28.

Summaries of the damage and nondamage data from the high-level blasts are given in figures 46 and 47. Most of the damage was observed in homes with interior walls of plaster on wood lath (Nos. 19, 27, 51) and consisted of extensions of existing cracks and new hairline cracks. House 20 was notable in being a modern 1-story home with gypsumboard interior walls. Unfortunately, this structure was sold by the mine and moved before more than superficial cracking could be inflicted. The lowest level for observed damage in this structure was 0.79 in/sec (shot 48).

House 21 was also a modern 1-story residence and had been subjected to nine large blasts including six exceeding 1.0 in/sec. No damage was observed that could be correlated to specific blasts. However, this home had a significant number of cracks around windows and doors. The block basement wall on the mine side had been falling inward and was being supported by steel bracing. The foundation deformation un-

doubtedly contributed to the superstructure's cracking.

House 61 was also a modern 1-story structure with both gypsum wallboard and plaster interior walls. This home was subjected to a peak particle velocity of 2.23 in/sec, and several cracks propagated over windows and doors.

House 67 was also damaged (by shot W-17); however, the blast was within 5 feet and the cracking was likely produced by permanent ground strain rather than elastic energy. This shot was not considered useful for damage analysis.

Frequencies were determined directly from the vibration time histories and by real-time spectral analysis. In some cases, the records showed two dominant frequencies; high-frequency for the first few hundred milliseconds, and then a significantly longer low-frequency wave train. The values of amplitude and frequency used corresponded to the part of the vibration record that produced the larger structure response, which was invariably the low frequency (7 to 30 Hz).

Some long-term observations were made of numbers of cracks, and their widths and lengths. None of these parameters could be related quantitatively to the blasting. The number of cracks increased with time regardless of the vibration levels, and their widths varied irregularly from a variety of environmental stresses. Consequently, blast damage was assumed only when immediate preblast and postblast inspections found additional cracks or extensions.

In all cases, except three shown in figure 45, blast damage was superficial cracking of the same type as caused by natural settlement, drying of building materials (shrinkage), and variations in wind, temperature, humidity, and

soil moisture. The three minor damage points in figure 46 represent cracks in masonry and large, new interior cracks exceeding 2 mm in width.

SUMMARY DAMAGE ANALYSIS

A summary analysis of damage was made using the 10 studies listed in table 9. To facilitate comparisons, a uniform classification of damage was adopted based on three levels of observed effects (table 10). The 10 studies of damage to residences from blasting produced a total of 553 observations, including 228 of various degrees of damage. These studies represent a variety of geologies, distances, and measurement methods. Data were analyzed in sets in order to group similar studies (table 11). Sets 1 and 3 were not unique enough to describe separately. Analysis involved both mean square fits and probability techniques.

Mean and Variance Analysis

The first analysis was made to determine mean and variance for the various damage classifications in terms of displacements as a function of frequency (figs. 48 to 52). This is analogous to the analyses performed for RI 5968 (14) and Bulletin 656 (37). A slope of minus 1 corresponds to a constant particle velocity, and a slope of minus 2 to a constant acceleration. A slope of zero is, of course, constant displacement.

Set 2 combines the two Canadian studies and that by Wiss, all giving similar results on glacial till. Sets 4 and 5 are the remainder of the low-frequency results with and without Dvorak's data, respectively. Set 6 is the high-frequency ground vibration data from Sweden (26) and from construction excavation (21). Set 7 is an overall summary of all the damage data.

Table 11.—Data sets used for damage analyses

Set and figures	Studies	Experimental conditions
1. (No plots)	Edwards and Northwood (16); Northwood, Crawford, and Edwards (38).	Low-frequency vibrations; glacial till soil/wallpaper on walls.
2. (Figs. 48, 53, and 55).	Edwards and Northwood (16); Northwood, Crawford, and Edwards (38); Wiss and Nicholls (57).	Do.
3. (No plots)	Morris and Westwater (31); Thoenen and Windes (51), quarry; Thoenen and Windes (51), shaker.	Low-frequency vibrations; walls stripped of wallpaper; plaster walls; shaker tests.
4. (Figs. 49 and 56).	Morris and Westwater (31); Thoenen and Windes (51), quarry; Thoenen and Windes (51), shaker, new Bureau of Mines (this study).	Do.
5. (Figs. 50, 53, and 57).	Dvorak (15); Morris and Westwater (31); Thoenen and Windes (51), quarry; Thoenen and Windes (51), shaker; new Bureau of Mines (this study).	As set 4 but with addition of masonry damage.
6. (Figs. 51, 53, and 58).	Jensen and Reitman (21); Langefors, Westerberg and Kihlstrom (26).	High-frequency vibrations.
7. (Figs. 52, 54, and 59).	Dvorak (15); Edwards and Northwood (16); Jensen and Reitman (21); Langefors, Westerberg, and Kihlstrom (26); Morris and Westwater (31); Northwood, Crawford and Edwards (38); Thoenen and Windes (51), quarry; Thoenen and Windes (51), shaker; new Bureau of Mines (this study).	Summary.

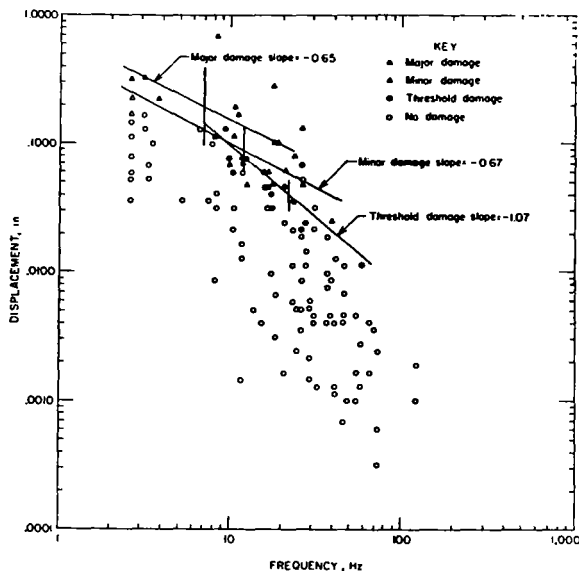

Figure 48.—Displacement versus frequency for low-frequency blasts in glacial till, set 2 mean and variance analysis.

Damage data for set 2 are shown in figure 48. The three mean regressions approximate constant particle velocities, particularly for the threshold case. All the individual damage points correspond to levels over 3 in/sec, with 2 in/sec roughly equal to three standard deviations⁸ below the threshold line. The minor and threshold lines cross because of the occurrence of some minor damage at levels below some of the threshold points observed from other shots.

Set 4 analysis shows the low-frequency data, consisting mainly of the old Bureau of Mines mechanical shaker damage and new coal mine blast damage (fig. 49). All the damage points are included, even that anomalous 0.001-in displacement, 40-Hz observation from the shaker experiment (equivalent to 0.31 in/sec).

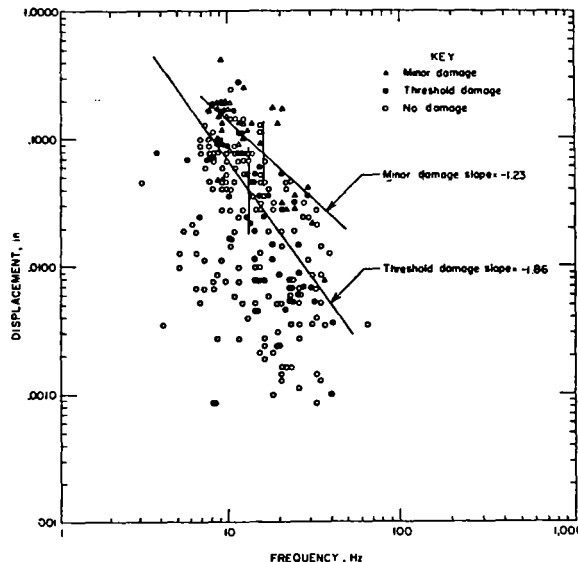

Figure 49.—Displacement versus frequency for low-frequency blasts and shaker tests, set 4 mean and variance analysis.

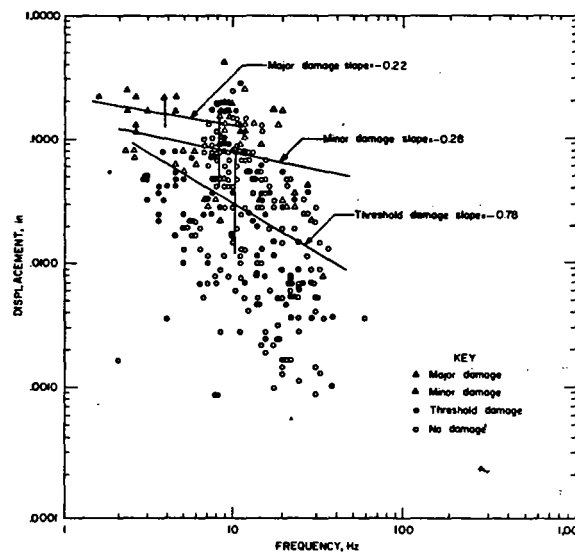

Figure 50.—Displacement versus frequency for low-frequency blasts, shaker tests, and masonry damage, set 5 mean and variance analysis.

⁸ The use of these statistical techniques is based on the assumption of a Gaussian distribution about the mean square regression fit. For damage data, which have an increasing monotonic probability at increasing levels, this is not rigorously accurate. Since the observations were in categories (or degrees), the means are roughly halfway between the damage onset for that category and the onset of the next category. This makes the damage means somewhat approximate except for the open-ended "major" classification. Statistical theory puts the following probabilities on occurrences lying outside a given number of standard deviations:

Standard deviations	Total probability outside high and low limit, pct	Probability outside low limit only, pct
1	32	16
1.64	10	5.0
2	4.6	2.3
2.33	2.0	1.0
3	.4	.2

Problems involved in this type of statistical analysis were discussed in Bulletin 656 (37).

Other than that single point, the lowest damage observed corresponded to approximately 0.72 in/sec, with quite a few points below 2 in/sec. The slopes are somewhat high, with the threshold line being almost equivalent to a constant acceleration that would have a slope of -2 . The standard deviations are large, with 2

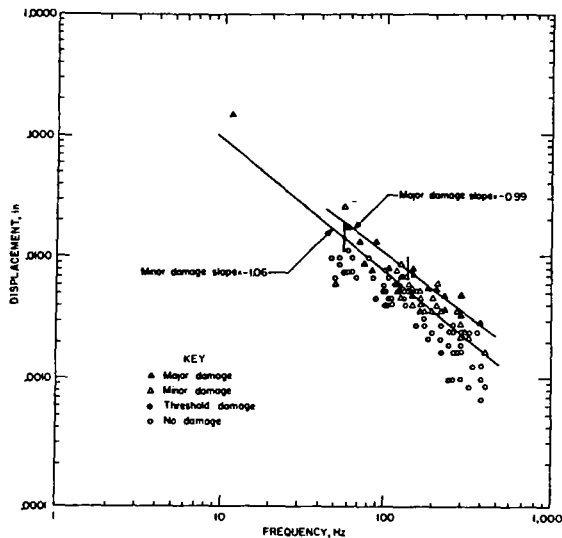

Figure 51.—Displacement versus frequency for high-frequency blasts, set 6 mean and variance analysis.

and 3 deviations from the mean threshold giving approximately 0.7 and 0.3 in/sec, respectively.

Set 5 (fig. 50) is a rerun of set 4, but with the addition of Dvorak's data (15). Standard deviations increased as expected, but the slopes are reduced. The threshold line approximates a constant particle velocity of 2 in/sec, with 1 and 2 standard deviations corresponding to roughly 0.7 and 0.3 in/sec, respectively (1 standard deviation lower than the set 4 results). The lower limit of the cracking data is enveloped by the 0.51 in/sec, excluding the single maverick point. The shallow slopes suggest that these low-frequency data approximate a displacement-bound condition, which is consistent with the observation that low-frequency vibrations (e.g., 5 Hz) produce large displacements (and strains). As an example, 1 in/sec at 5 Hz is equivalent to 0.032-in displacement, which is twice the British recommended maximum of 0.016 in for vibrations below 5 Hz. The large amount of scatter in the low-frequency data is undoubtedly related to the structure response frequencies being in the same range. Between 4 and 25 Hz, the response, hence the damage for any given structure, will depend strongly on frequency. Therefore, the large amount of scatter is to be expected in a summary involving many shots and structures.

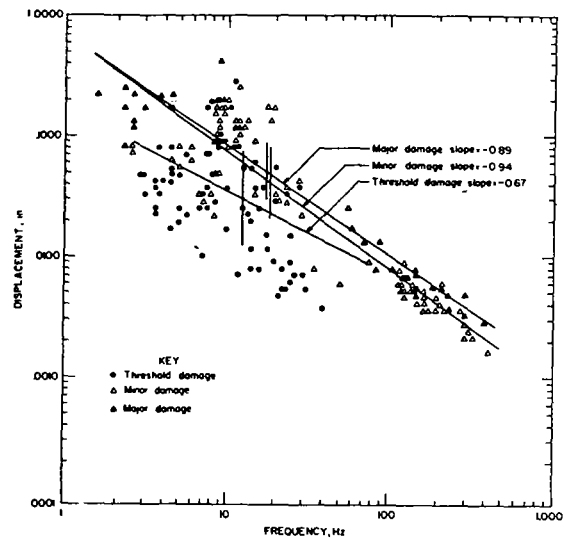

Figure 52.—Displacement versus frequency summary, set 7 mean and variance analysis.

The high-frequency damage cases are shown by set 6 analysis (fig. 51), with the observation of only two classes of damage. Most notable are the minus 1 slopes (constant particle velocities), small scatter, and relatively high vibration levels for damage. No damage was observed below 2 in/sec. This level also corresponds to >3 standard deviations from the minor damage mean (lowest class of damage observed).

Set 7 (fig. 52) is an overall summary of all the damage data. The nondamage points have been omitted for clarity. This figure is analogous to the similar damage summaries in RI 5968 (14, fig. 6) and Bulletin 656 (37, fig. 3.4). The statistics corresponding to this summary analysis are somewhat arbitrary, being an artifact of the relative amount of high- and low-frequency data available. The large amount of scatter for the low frequencies shows that greater caution is required for equivalent damage probability as compared with that for high-frequency vibrations, those exceeding approximately 50 Hz. Regressions of the mean damage levels for the various sets have been plotted as particle velocities versus frequencies in figure 53, with the overall summary shown in figure 54. The maverick low point from figures 49 and 50 has been omitted as experimental error in the summary figures (figs. 52 and 54).

Probability Analysis

Probability analyses were also applied to the damage data as an alternative to regression analysis and were expected to produce more meaningful predictions. The number of damage observations within particle velocity intervals were plotted for the various sets of data. Four sampling methods were used on the damage and nondamage observations:

1. Simple counting of the numbers of points within an interval.
2. Smoothed sampling with variable-width particle velocity windows.
3. Assuming that every damage point excludes the possibility of higher level nondamage for that particular test with the reverse for nondamage.
4. Using only damage points and accumulated damage at increasing levels, and the same assumption for nondamage as for observation 3 above.

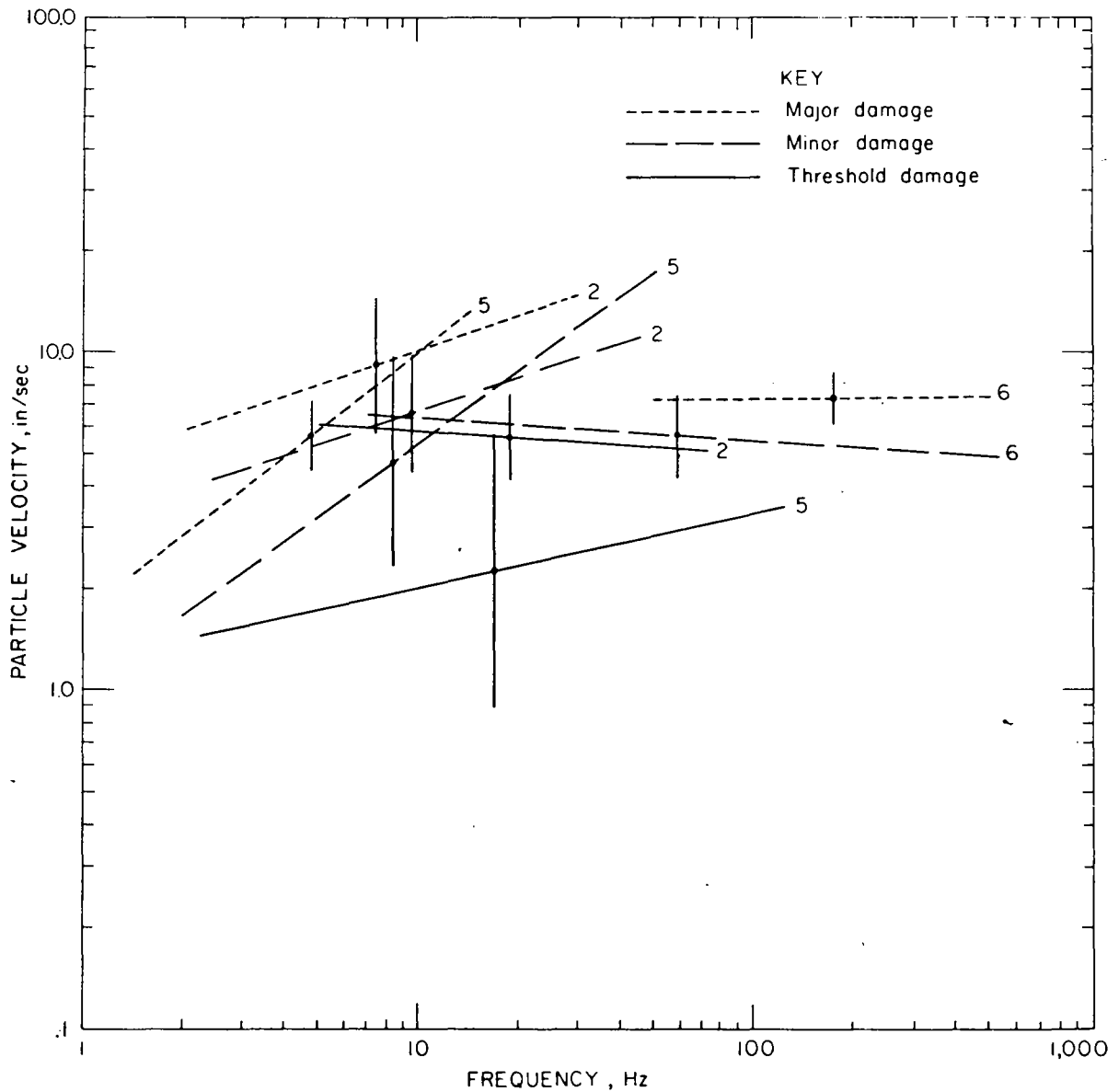

Figure 53.—Velocity versus frequency for the various damage data sets, mean and variance analysis. Sets are given in table 11.

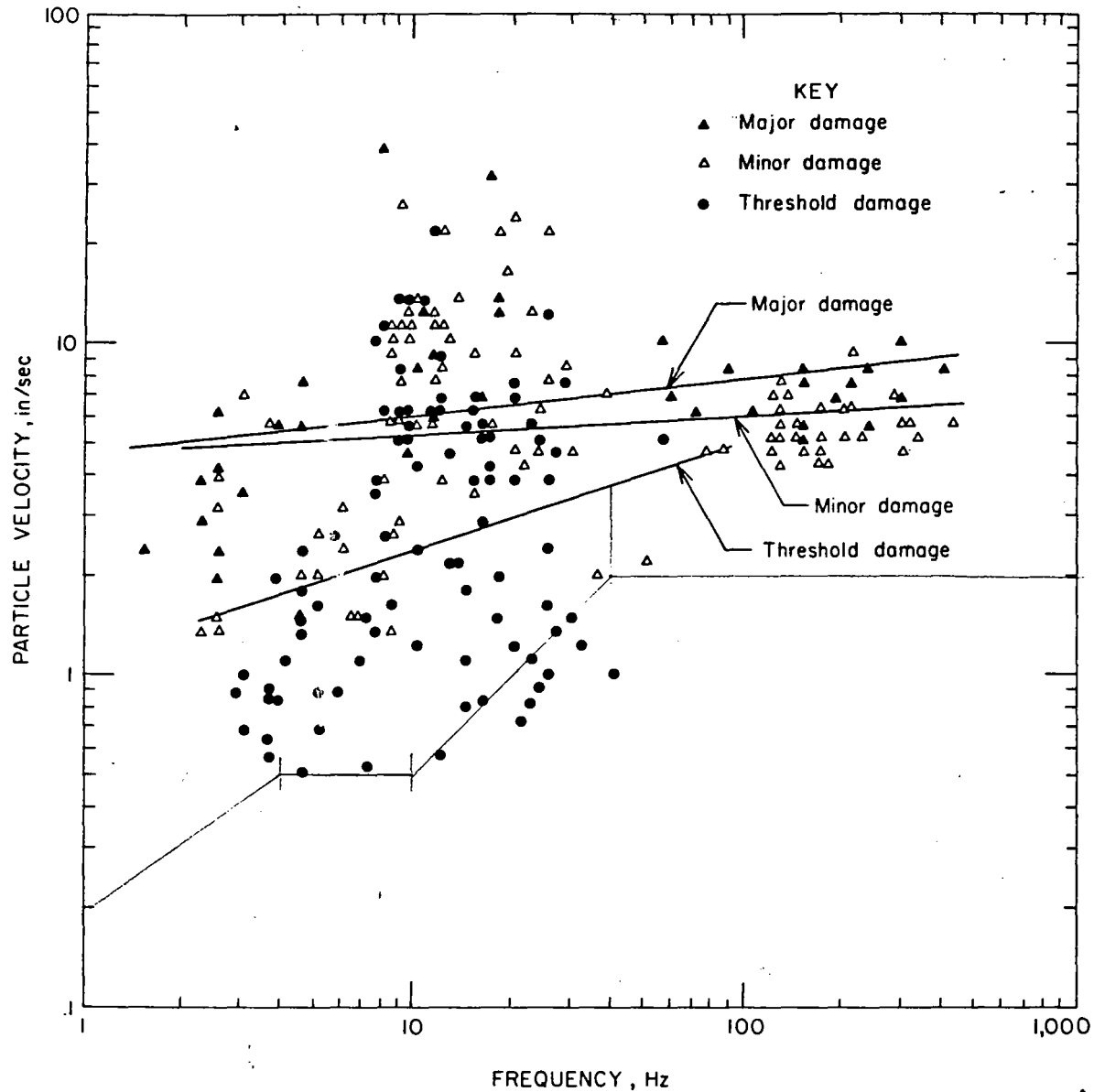

Figure 54.—Velocity versus frequency summary, set 7 mean and variance analysis.

All the sampling methods except the last violated one or more of the basic principles: (1) that the probability of damage must be independent of the sampling interval or (2) independent of the number of points (of damage or nondamage) in a given sample, and (3) that the number of new damage points must increase as levels increase. The first two principles are essential, that the probabilities concern the physics of the problem and are not a statistical artifact. The last is a result of the experimental design

that involves steadily increasing levels of vibration until damage is observed. This places the observations on the upward curving part of the probability plot. When the cumulative damage was initially plotted on linear scales, they showed very little (essentially zero) damage at low levels and all damage (essentially 100 pct) at high levels. Between these extremes is the familiar S-shaped probability curve. On a log-normal ruled probability scale, the data plot as a straight line if they have the kind of log-normal distribution found for sonic boom glass breakage (46).

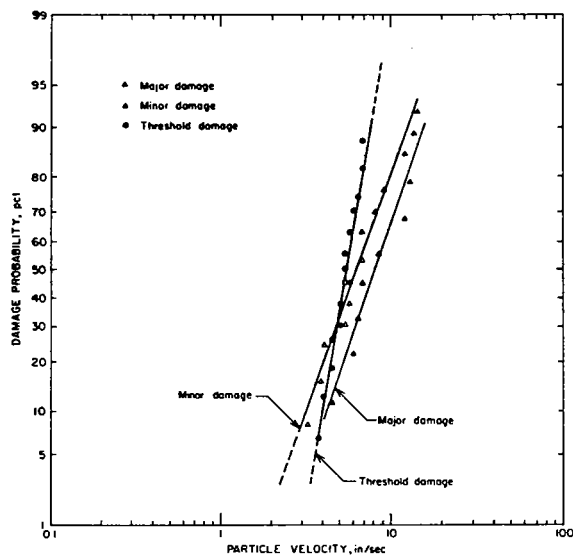

Figure 55.—Probability damage analysis for low-frequency blasts in glacial till, set 2.

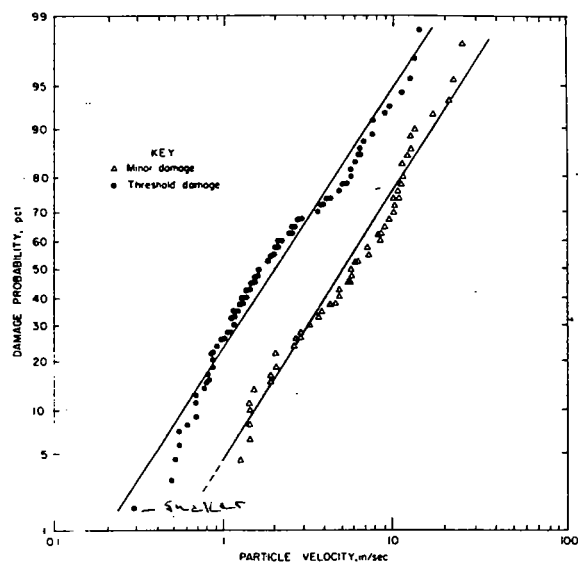

Figure 57.—Probability damage analysis for low-frequency blasts, shaker tests, and masonry damage, set 5.

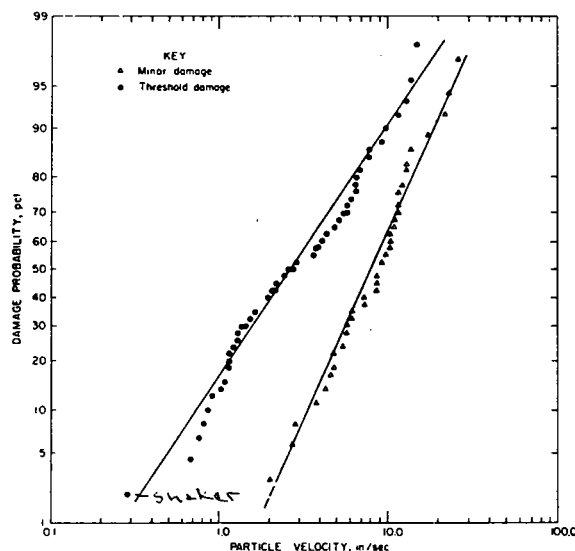

Figure 56.—Probability damage analysis for low-frequency blasts and shaker tests, set 4.

Log normal-scaled damage probability curves are shown in figures 55 to 59, for the same sets of studies analyzed for mean regressions. Data from the individual studies plotted as good straight-line fits, and even combining studies with apparent experimental differences still yielded high correlation coefficients.

The set 2 damage probabilities are shown in figure 55. This is primarily the two Canadian studies (16, 38), and as with the analysis of mean

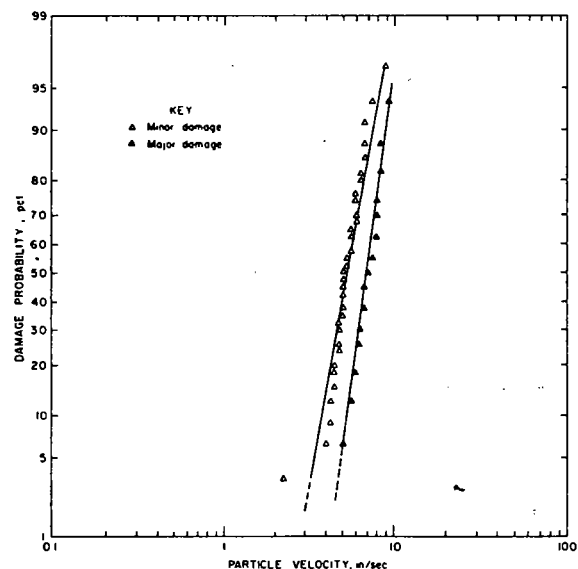

Figure 58.—Probability damage analysis for high-frequency blasts, set 6.

and variance, the threshold and minor damage lines cross. Projection of the probability lines for these data shows a low probability of damage below 2.0 in/sec (2 pct or less).

Sets 4 and 5 are shown in figures 56 and 57, respectively. These are again the low-frequency damage cases and the early Bureau of Mines shaker data. Set 5 includes Dvorak's study (15).

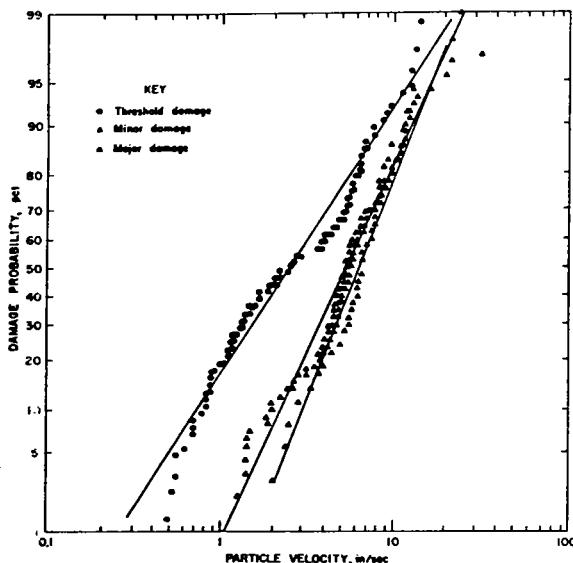

Figure 59.—Probability damage analysis summary, set 7.

The single very low valued maverick point is still included, and it produces the apparent discontinuity at the lowest vibration level. For both sets 4 and 5 probability plots, the mean line, and the trend from the individual points differ considerably at the lower probabilities. Statistical reliability increases results when the actual statistical points rather than the mean line is used for predictions. Consequently, the 5-pct damage probabilities from sets 4 and 5 are 0.80 and 0.53 in/sec, respectively.

The probability of damage from high-frequency vibrations is shown in figure 58 for set 6 data. By contrast to sets 4 and 5, data for set 6 form an excellent straight-line fit and have very steep slopes. The damage occurs over a narrow range of particle velocities, and as with the mean analysis of damage (fig. 51), it strongly supports the use of particle velocity. The vibration levels are again very high, exceeding approximately 2 in/sec for probabilities of 5 pct and below. The Swedish data alone would support a somewhat higher level, such as 3.5 in/sec for 5 pct and 3.0 in/sec for 1 pct.

The set 7 analysis (fig. 59) again represents the overall summary of all 10 sets of data. That single odd point was removed for the same reasons that it was dropped in the earlier analyses (14, 37).

Most notable is the downward turn of the damage probabilities at low vibration levels, suggesting a departure from log-normal predictions and some kind of asymptotic probability toward zero damage. However, precise predictions at increasingly lower levels must necessarily become less reliable. Accurate probability figures require a large number of observations, and even this summary analysis does not have excess data, particularly for each of the principal experimental variables.

SAFE BLASTING LEVELS

The damage statistics from figures 48–59 are summarized in table 12. Safe vibration levels are suggested by the three sets of values, two from statistical analyses and a third from the simple observation of the lowest level at which damage occurred. The mean and variance values are of limited use, owing to several problems with the data. They show (for set 2) that minor damage is predicted at lower vibration levels than threshold damage. This is caused by the crossing of the means and different relative magnitudes of the standard deviations. They also produced particle velocity levels that are frequency dependent for cases where the slopes do not approximate minus 1 (set 4, threshold; set 5, minor and major; set 2, minor and major). For predictive purposes, the probability analysis results are more reliable. The lowest values of damage actually observed correspond quite closely to the 5-pct damage probabilities, except for the high-frequency data (set 6).

Safe vibration levels for blasting are given in table 13, being defined as levels unlikely to produce interior cracking or other damage in residences. Implicit in these values are assumptions that the structures are sited on a firm foundation, do not exceed 2 stories, and have the dimensions of typical residences, and that the vibration wave trains are not longer than a few seconds.

A minimum safe level of 0.50 in/sec for blasting was adopted from table 12 based on the probit analyses of set 5 (low-frequency shots) and set 7 (overall summary). This assumes a 5-pct probability for very superficial cracking. However, this vibration level is also lower than the lowest level in cases where damage was observed. The almost-constant particle velocities for the lower damage probabilities of 2 and 1 pct (threshold, set 7) strongly suggest that the

Table 12.—Summary of damage statistics by data sets

Type of damage ¹	Peak particle velocities, in/sec						Envelope of low- est observed damage
	Mean and variance analysis, standard deviations			Probability analysis			
	1.64(5 pct)	2.05(2 pct)	2.33(1 pct)	5 pct	2 pct	1 pct	
Threshold:							
Set 2 -----	3.4	3.0	2.8	3.5	² 3.2	² 3.0	3.8
Set 4 -----	.88	.63	.50	.70	NA	NA	.72
Set 5 -----	.46	.31	.24	.52	.32	NA	.51
Set 7 -----	.54	.36	.28	³ 5.3	³ 4.8	³ 4.6	.51
Minor:							
Set 2 -----	3.0	2.6	2.3	² 2.5	² 2.1	² 1.7	3.1
Set 4 -----	3.0	2.3	2.0	2.5	² 2.0	NA	2.0
Set 5 -----	1.3	.98	.80	1.3	² 1.0	NA	1.4
Set 6 -----	3.3	3.0	2.8	3.1	NA	NA	2.2
Set 7 -----	1.6	1.2	1.0	1.4	² 1.2	² 1.1	1.4
Major:							
Set 2 -----	2.6	1.9	1.6	² 3.3	² 2.7	² 2.4	4.5
Set 5 -----	2.6	2.2	2.1	NA	NA	NA	2.0
Set 6 -----	5.0	4.6	4.2	4.8	4.4	NA	5.5
Set 7 -----	2.3	1.9	1.6	2.3	1.8	1.6	2.0

NA = Not available.

¹ No threshold analysis exists for set 6; no major analysis exists for set 4.² Extrapolated line.³ Maverick point was deleted.

0.50-in/sec level will provide protection from blast damage in > 95 pct of the cases. The damage probabilities realistically refer to numbers of homes being affected by a given shot rather than the number of shots required to damage a single home. This results from the much wider variation of damage susceptibilities among structures with various degrees of prestrain as compared with a time-dependent susceptibility for a given structure. Additional work on fatigue and special soil and foundation types may later justify stricter criteria.

Data are insufficient for a thorough analysis of the damage potentials in structures of various construction types. However, the values in table 13 are obviously dominated by houses that are susceptible to cracking. Most of the observed damage listed in table 9 involved plaster cracking in older structures. Modern Drywall (gypsumboard) interior-walled homes are apparently more capable of withstanding vibrations, since the paper-backed wallboard is relatively

Table 13.—Safe levels of blasting vibrations for residential type structures

Type of structure	Ground vibration—peak particle velocity, in/sec	
	At low frequency ¹ (<40 Hz)	At high frequency (≥40 Hz)
Modern homes, Drywall interiors -----	0.75	2.0
Older homes, plaster on wood lath construction for interior walls -----	.50	2.0

¹ All spectral peaks within 6 dB (50 pct) amplitude of the predominant frequency must be analyzed.

stiff and nonbrittle. Only two studies specifically examined Drywall damage from blasting, Wiss' (57) and the new Bureau of Mines measurements. The lowest vibration level corresponding to very minor crack extensions was 0.79 in/sec (structure 20), and many nondamage observations were made at levels exceeding 2.0 in/sec. Consequently, there is little justification in using the conservative 0.50 in/sec or anything lower for modern construction, and in this case 0.75 in/sec is a good minimum criterion. The conservative 2.0 in/sec is justified for the high-frequency blasts, even though the 5-pct value is 3.2 in/sec. This is based on the lowest observed damage value of 2.2 in/sec and the fact that no observations were made of damage corresponding to the "threshold" criteria of the other studies. Construction and excavation blasting will often fall in this high-frequency category.

Estimation of the predominant frequency is still a problem. Where the wave train is simple, the period corresponding to the peak level can be directly measured. Otherwise, some kind of spectral analysis is required. Complex vibration time histories consist of a variety of frequencies and amplitudes, so a visual estimate of frequency can be misleading. Occasionally, the peak level occurs early in the wave and at a high frequency, with a long-duration wave train of somewhat lesser amplitude following. The safest approach is to consider the low-frequency part of the time history separately, and where it is below 40 Hz, use the 0.75 in/sec or 0.50 in/sec criteria. If Fourier spectral analysis is used, any spectral peak occurring below 40 Hz and within

6 dB (half amplitude) of the peak at the predominant frequency justifies the use of the lower criteria.

A more complex scheme of assessing the damage potential of blast vibrations is possible, using a combination of particle velocity and displacement (appendix B). This permits higher levels for the intermediate-frequency cases (15 to 40 Hz) but requires lower particle velocities for the lowest frequencies (< 4 Hz). The measurement complexity will make this impractical for many situations.

RESPONSE SPECTRA ANALYSIS OF DAMAGE CASES

Damaging and nondamaging blast vibration time histories were examined for single degree

of freedom response by Corser (8). Four old houses were analyzed, Wiss' single structure (57) and three from the new Bureau analysis (houses 19, 27, and 51). Corser found that the shapes of the response spectra were not noticeably different for those that produced damage and for similar blasts that did not, but they had higher

pseudo velocities. The response spectra were mostly displacement-bound at the lower frequencies (less than 20 Hz), which includes the range of whole-structure response frequencies.

The lowest damage line was equivalent to structural displacements of roughly 0.012 to 0.014 in, consistent with the old British practice of taking special precautions where ground vibration levels exceed 0.016 in at frequencies below 5 Hz.

EXISTING STANDARDS FOR VIBRATIONS

A variety of vibration standards are in use or under consideration. They are intended to prevent damage to structures as well as to a great variety of other objects (e.g., computers), and also to control annoyance effects. Establishing safe and appropriate levels for all situations is well beyond the scope of this study. However, these blast vibration studies represent a major

part of the research effort in this technical area. The results are often applied to situations far removed from cracking prediction in houses from short-duration, ground-transmitted vibrations. For this reason, existing blast vibration standards and reported vibration tolerances are presented in the section on Human Response and in appendix A.

HUMAN RESPONSE

The tolerance and reactions of humans to vibrations are important when standards are based on annoyance, interference, work proficiency, and health. Humans notice and react to blast-produced vibrations at levels that are lower than the damage thresholds. Similar problems also exist for annoyance from sonic booms and airblasts, and these are discussed in a related study of airblasts (46). The technical problem of quantifying responses is complicated by the simultaneous presence of both ground vibration and airblast and the many secondary effects of wall-produced window, dish, and bric-a-brac rattling. Persons inside buildings will hear and feel the predominantly 5- to 25-Hz structure midwall and midfloor response vibrations (45). Ground vibrations are occasionally blamed for house vibrations when long-range airblasts propagating under favorable weather conditions are responsible. The very infrasonic airblast itself cannot be heard, but the house responds as if subjected to a ground vibration.

Critical to levels of response are the vibration characteristics (duration, peak level, vibration frequency, and frequency of occurrence), reaction descriptors (startle, fright, fear of damage, sleep, or other interference), and tolerance descriptors (health and safety endangered, work or proficiency, and comfort or annoyance boundaries). Running like a thread through the already complex fabric are social, economic, and legal factors, typified by the importance of the vibration source to the Nation, community, or individuals involved. Examples are the temporary or indefinite nature of this environmental intrusion, beliefs in the inevitability of the source, and the social consciousness of the blaster (as shown by his public relations program and blast design efforts that minimize ground vibrations and airblast).

Most studies of human tolerance to vibrations have been of steady-state sources or those of relatively longer duration than typical mine, quarry, and construction blasting. In the absence of data on tolerance to impulsive vibrations, these results have been assumed to be applicable to blasting. Additionally, most useful data are from tests involving human subjects directly, when not in their homes. The duration and frequency of occurrence of the events are obviously critical. The vibration limits required

for reasonable comfort from a long-term vibration source (e.g., air conditioning, machinery, building elevators, and vehicle traffic) are certainly more restrictive than for sources of short duration and infrequent occurrence.

The classical study of subjective human tolerance to vibratory motion was done by Reiher and Meister in 1931 (40). They subjected 15 people to 5-min duration vertical and horizontal vibrations in a variety of body positions and established levels of perception and comfort. Responses of "slightly perceptible" occurred at 0.010 to 0.033 in/sec, and the threshold of "strongly perceptible" was 0.10 in/sec, all essentially independent of frequency over the range 4 to 25 Hz.

More recent research on the effects of vibration on man have produced results similar to those of Reiher and Meister (2, 18, 55). Goldman analyzed human response to steady-state vibration in the frequency range of 2 to 50 Hz (18). His results were converted to particle velocities and presented in Bulletin 656 (37, fig. 3.9), where the lines represent means within each response category. One standard deviation of the reactions was at approximately half the level of the means. Goldman's "slightly perceptible" and "strongly perceptible" (unpleasant) levels at 1.65 standard deviations (including all but 5 pct at the low end) are approximately 0.0086 and 0.074 in/sec, respectively, at 10 Hz. Taking these as thresholds, they agree quite well with Reiher and Meister's data.

Several researchers recognized that the duration of the vibration was critical to its undesirability. Most evident was that a higher level could be tolerated if the event was short. Consequently, steady-state vibration data could not be realistically applied to blasting, except for events that exceed several seconds' duration. A good example of a long event was the Salmon nuclear blast (37, 39). This was technically a transient; however, the 90-sec-long, low-frequency wave train produced at large distances resulted in numerous complaints (10 pct of all families at 0.40 in/sec). This duration exceeds that of any kind of mining blasts. Chang analyzed the human vibration response literature with particular attention to event durations (7). He noted that Reiher and Meister's responses could be multiplied by a factor of 10 for short events. Atherton studied impact- and walking-

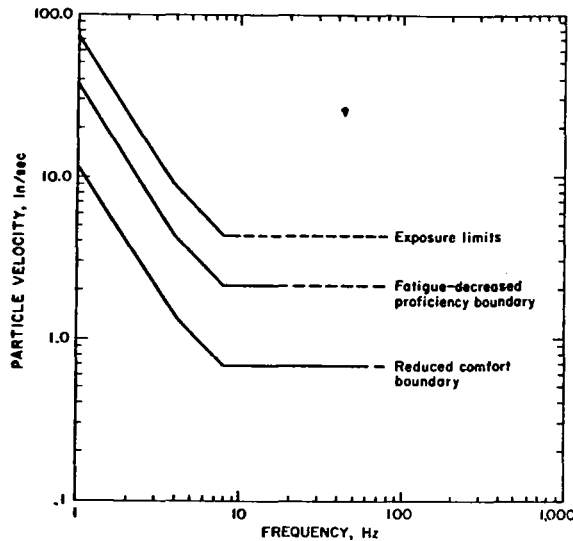

Figure 60.—Human tolerance standards for rms vibrations exceeding 1-minute-duration ISO 2631.

produced floor motions. His impact tests consisted of 3 to 5 cycles of motion at 19 Hz (the floor resonance), or events of approximately 200-msec duration. His "disturbing" level mean was 3.5 to 4.4 in/sec, or over 5 times Goldman's steady-state "intolerable" level of 0.77 in/sec at 20 Hz.

The International Standards Organization (ISO) published tolerable levels for whole body vibration in 1978 (19). The scope of their standard included durations of 1 min and longer, frequencies of 1 to 80 Hz, three-axis vibrations, and human tolerances for comfort, working efficiency, fatigue, and health and safety. Their recommendations for 1-min-duration events are shown in figure 60, having been converted from accelerations to particle velocities and corresponding to the worst-case body orientation (longitudinal or Z-axis). All values are rms and are constant particle velocities for frequencies above 8 Hz. Peak values would be larger by a factor of 1.4 to 3. The dashed part of the lines in figure 60 represent peak accelerations in excess of 1 g.

Wiss and Parmelee studied the responses of 40 people to transient vibrations consisting of damped 5-sec sinusoidal pulses (58). Damping ranged from zero to 16 pct and frequencies from 2.5 to 25 Hz. All subjects were standing on an open platform and subjected to vertical vibrations. They found that responses depended on vibration levels and damping but were in-

dependent of frequency, when plotted in units of frequency times displacement (velocity). Their results, and the two steady-state vibration studies, are shown in figure 61. The various experimental factors for the three studies are listed in table 14. The reaction descriptors were different, a sign of the subjective nature of this kind of work. "Thresholds" correspond to the responses of the most sensitive people tested. "Means" are the responses of the "average subject" within each response descriptor category. Between Goldman's "unpleasant" and "intolerable" (G-2 and G-3) lies the ISO "reduced comfort boundary". Wiss and Parmelee's results were reanalyzed for duration-of-vibration effects, with damping, frequency and duration being interrelated. It was assumed that the vibration duration is the time during which the vibration level exceeds 10 pct of the peak (-20 dB). The following relationship was derived:

$$\tau = \frac{0.67}{f\beta} + 0.018$$

where τ is the duration (sec), f the frequency (Hz), β is the damping ratio, and 0.018 the average input rise time (sec). Application of this equation to Wiss and Parmelee's test runs allows durations to be calculated for the various reactions that become slightly frequency dependent when plotted as particle velocities (fig. 62), and very much so when plotted as accelerations (fig. 63).

Table 14.—Studies of human response to vibration

Authors	Vibration duration, sec	Curve representations, response descriptors, and curve label for data plotted in figure 61
Goldman (18): Various body positions, 5 sources	5	Mean values of subject response: Perceivable (curve G-1). Unpleasant (curve G-2). Intolerable (curve G-3).
Do	5	
Do	5	
Reiher and Meister (40): Standing with vertical vibration	300	Thresholds: Barely noticeable (curve R-1). Objectionable (curve R-2). Uncomfortable (curve R-3).
Do	300	
Do	300	
Wiss and Parmelee (58): Standing with vertical vibration	5	Mean values of subject response: Barely perceptible (curve W-1). Distinctly perceptible (curve W-2). Strongly perceptible (curve W-3).
Do ¹	5	
Do ¹	5	
Do ¹	5	Thresholds: Barely perceptible (curve W-4). Distinctly perceptible (curve W-5). Strongly perceptible (curve W-6). Severe (curve W-7).
Do ²	5	
Do ²	5	
Do ²	5	

¹ Transient with 1 pct damping, 5-sec duration is maximum.

² Zero damping.

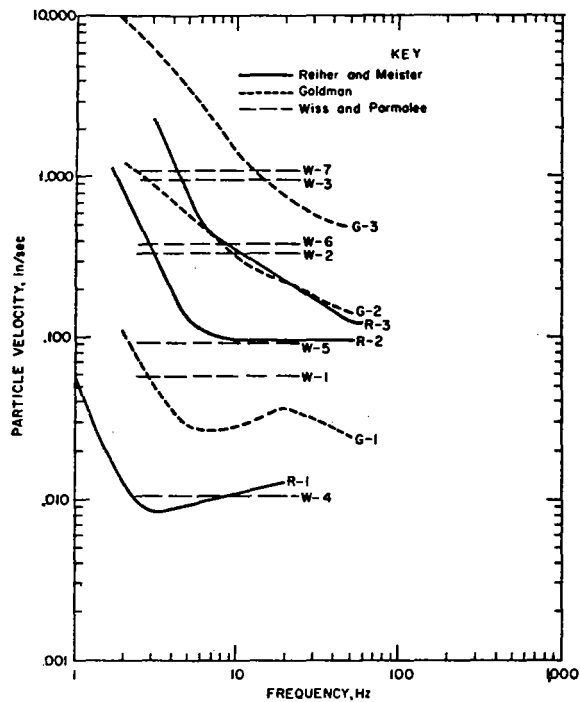

Figure 61.—Human response to steady-state and transient vibrations. Labels refer to measurements listed in table 14.

T. M. Murray investigated human reactions to vibrations of concrete floors (33). His summary of 91 observations of acceptable versus unacceptable cases indicated strong influences for amplitude times frequency (same units as particle velocity) and damping levels. He derived the following relationship for an acceptable concrete floor:

$$\beta \geq 35Af_0 + 2.5$$

where β is percent of critical damping (damping ratio $\times 100$), A is initial amplitude from a heel-drop impact (in), and f_0 is the first natural frequency (Hz). Murray's data were converted to peak particle velocities and are shown in figure 64. The line represents the equation above and is Murray's eyeball separation between acceptable and unacceptable cases. Acceleration and displacement plots were also made from Murray's data and, unlike the particle velocity data, they showed a strong frequency influence.

As with Wiss' data, Murray's 91 points were converted into duration-amplitude form using the relationship:

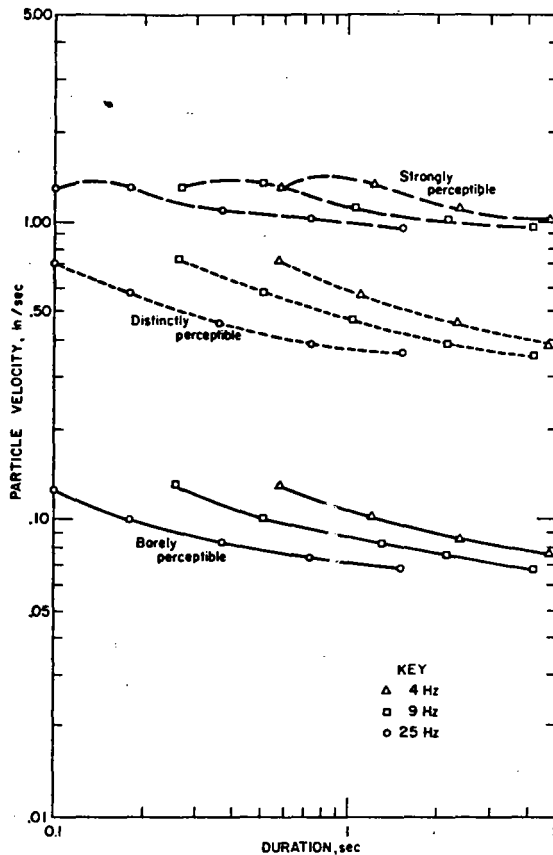

Figure 62.—Human response to transient vibration velocities of various durations.

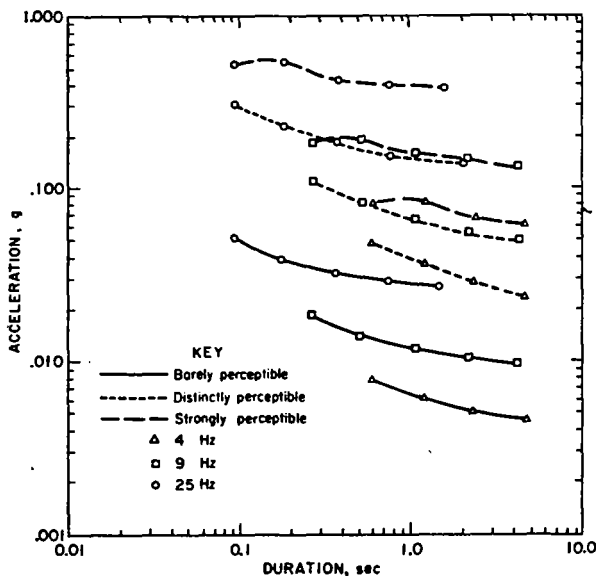

Figure 63.—Human response to transient vibration accelerations of various durations.

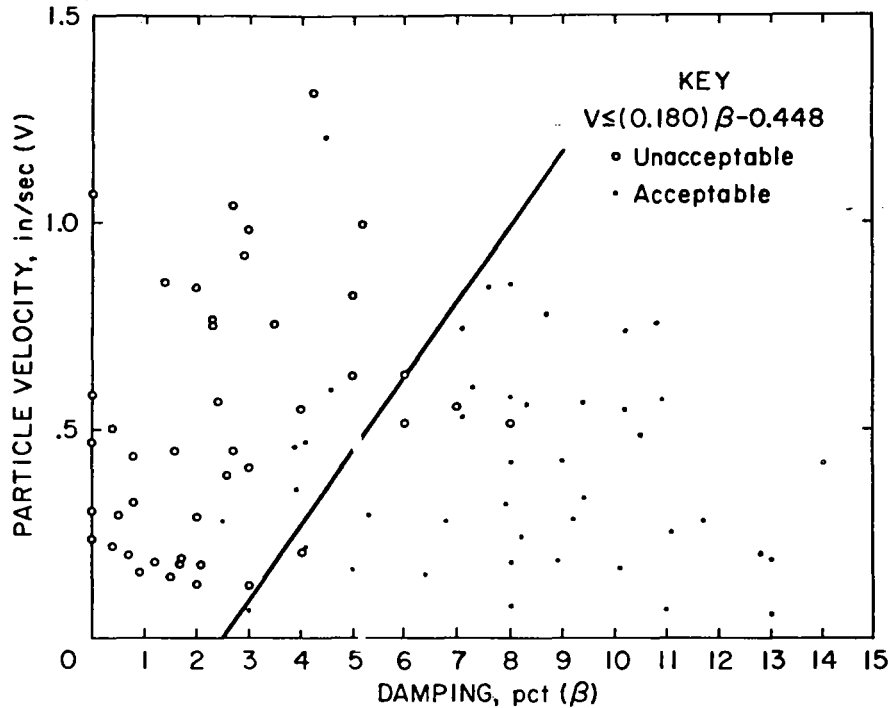

Figure 64.—Human response to vibrations of damped concrete floors, after Murray (33).
Equation defines acceptable zone.

$$\tau = \frac{36.7}{\beta f}$$

where β is the percentage of critical damping.

The results, given in figure 65, show a strong influence on acceptability of both floor velocity and vibration duration. As in Murray's analysis, a separation of cases was derived by visual means and produced the following acceptability criterion:

$$V \leq 0.415 \tau^{-1.29}$$

where V is the peak floor vibration (in/sec) and τ is the time (sec) from the peak to the minus 20-dB level (or 10 pct of peak amplitude). The amplitude-duration acceptability line shows a better defined separation of cases than Murray's original amplitude-damping version.

As with Murray's damping version of the data, the duration version did not produce simple relationships when plotted as accelerations and displacements, with frequency factors and non-linear plots required. Murray suggests that his acceptability criteria for concrete floors may be conservative compared with that for wooden floors, where a greater amount of vibration is normally expected.

Human reactions to events of varying durations are summarized in figure 66, with the values given in table 15. In cases where "distinctly perceptible" applies (i.e., infrequent and short-duration events), these results suggest that levels of over 0.5 in/sec could be tolerated. The barely perceptible levels are still below 0.1 in/sec; consequently, it is impractical for blasting ever to be totally unobtrusive.

The studies just discussed all involve people in a test situation rather than in their own homes. None of the problems of damage fear, startle, house rattle, and other secondary effects were present. Undoubtedly, the addition of such effects lowers the thresholds at which people react. Relationships have been developed for people subjected to sonic booms and airblasts in their "normal" environment (46).

An estimate of annoyance from indoor-perceived ground vibration can be made by comparing airblast and ground vibration-produced midwall response (fig. 41), and the annoyance curves from airblast study. Estimated ground-vibration-produced human reactions are given in figure 67 based on the airblast responses from figure I-1 of RI 8485 (46). These are for coal mining; quarry levels are 20 pct higher. The three lines of the figure show the distribution

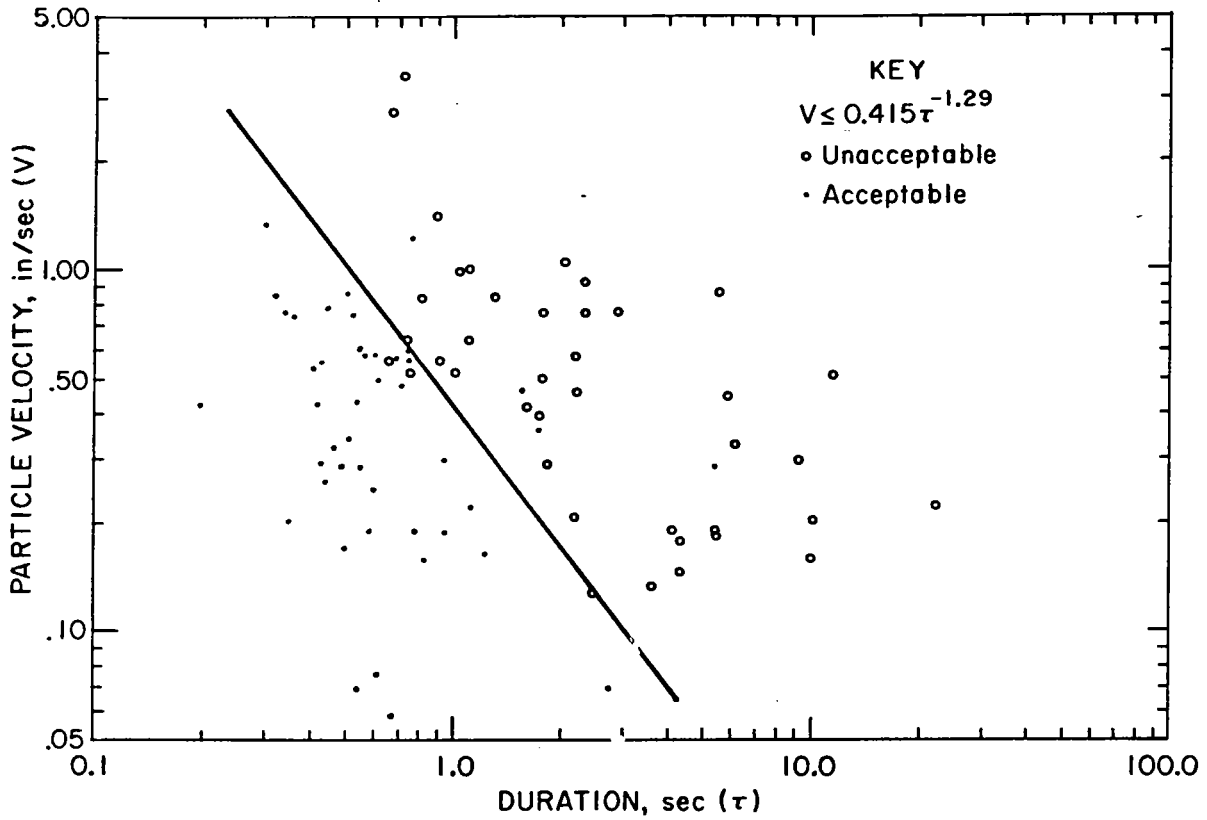

Figure 65.—Human response to concrete floor vibrations of various durations. Equation defines acceptable zone.

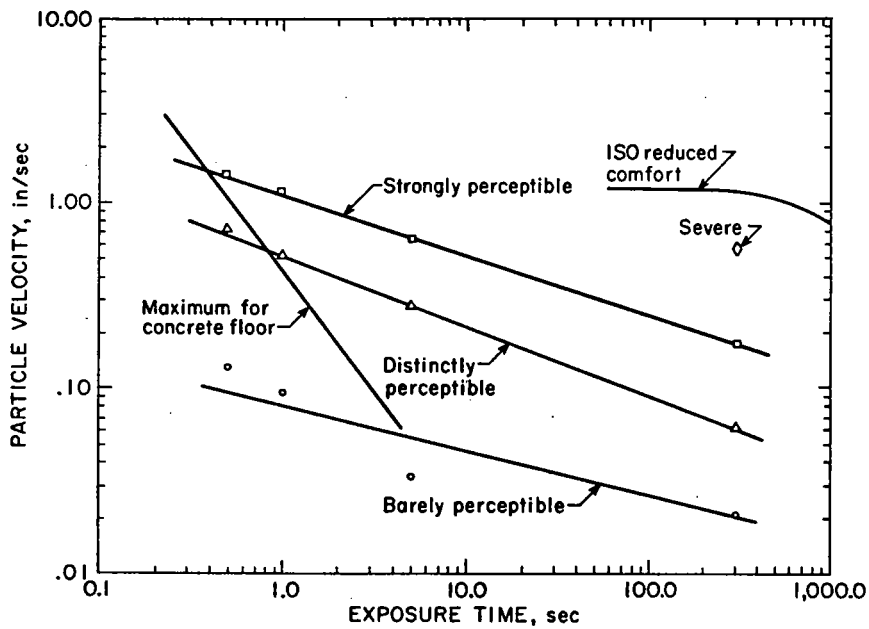

Figure 66.—Human response to vibrations of various durations, summary. ISO values are from Standard 2631.

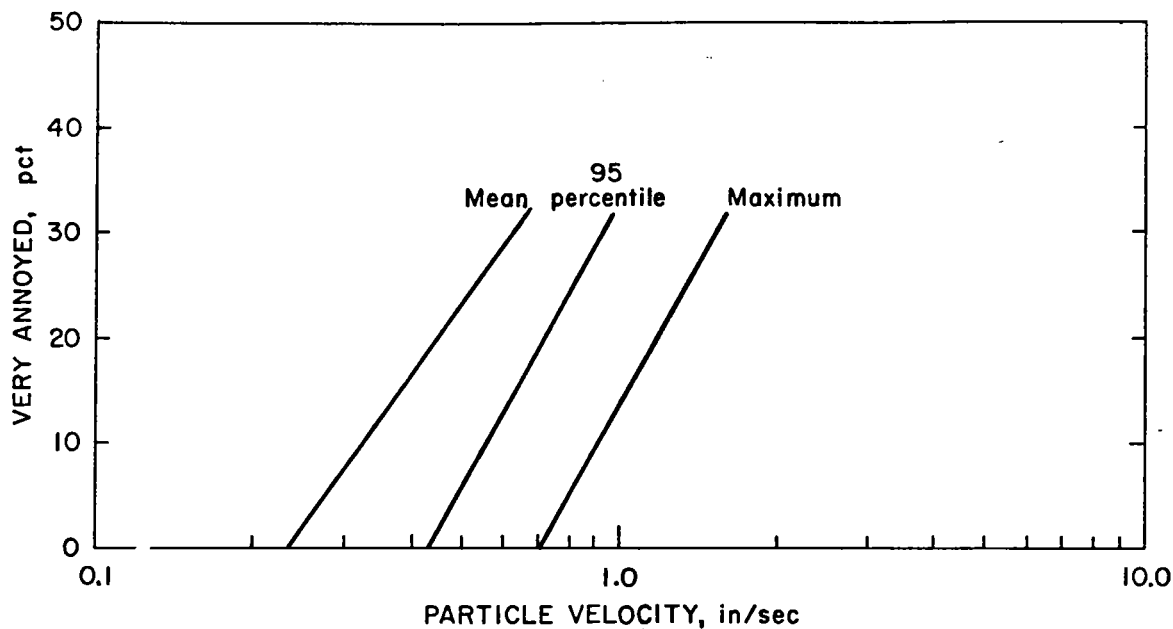

Figure 67.—Reactions of persons subjected to blasting vibration in their homes.

of the particle velocities. Since reactions are most likely from stronger events, actual public reaction would occur somewhere between that corresponding to the mean vibration level and the maximum, probably close to the 95th percentile. Exact determination of the airblast-produced human reactions (and also those produced by ground vibration) is not possible without knowing how closely the reported subjective reactions correspond to various levels of sonic boom experienced during the three test periods. It is possible and even likely that those interviewed reacted more to the higher level booms (e.g., maximum values). More work is needed to quantify reactions and specific levels. The potential for ground vibrations to produce strong public reaction is evident from figure 67. In the absence of a public relations program, it is expected that a mean ground vibration level of 0.50 in/sec in a community will produce 15 to 30 pct "very annoyed" neighbors. The 95-pct line gives 5 pct very annoyed at 0.5 in/sec. The blaster must convince the nearby homeowners that the rattling is to be expected and is not damaging. He can also demonstrate his sincerity by blasting as unobtrusively as possible, and using the best blast design principles.

Table 15.—Subjective responses of humans to vibrations of various durations

Type of response	Duration, sec	Particle velocity, in/sec	Source
Barely perceptible:			
Mean	0.5	0.130	Wiss and Parmelee (58).
Do	1	.095	Do.
Do	5	.033	Do.
Do	300	.020	Reiher and Meister (40).
Threshold	5	.011	Wiss and Parmelee (58).
Do	300	.011	Reiher and Meister (40).
Distinctly perceptible:			
Mean	.5	.700	Wiss and Parmelee (58).
Do	1	.500	Do.
Do	5	.280	Do.
Do	300	.060	Reiher and Meister (40).
Threshold	.5	.300	Wiss and Parmelee (58).
Do	1	.230	Do.
Do	5	.100	Do.
Do	300	.033	Reiher and Meister (40).
Strongly perceptible:			
Mean	.5	1.400	Wiss and Parmelee (58).
Do	1	1.150	Do.
Do	5	.630	Do.
Do	300	.170 ¹	Reiher and Meister (40).
Threshold	.5	.910	Wiss and Parmelee (58).
Do	1	.810	Do.
Do	5	.390	Do.
Do	300	.102	Reiher and Meister (40).
Severe:			
Mean	300	.550 ¹	Do.
Threshold	5	1.13	Wiss and Parmelee (58).
Do	300	.301	Reiher and Meister (40).
Acceptable	0.2-4	≤0.415 ^{1,29}	Murray (33). ²

¹ At 9 Hz.

² τ = duration (sec).

CONCLUSIONS

The problems of blasting vibration damage to residential structures and human tolerance to vibrations have been analyzed using data from a wide variety of studies. Statistical techniques of mean and variance analysis and probability plots have both been applied to the damage data from the 10 studies and demonstrated the following:

1. Particle velocity is still the best single ground motion descriptor.

2. Particle velocity is the most practical descriptor for regulating the damage potential for a class of structures with well-defined response characteristics (e.g., single-family residences).

3. Where the operator wants to be relieved of the responsibility of instrumenting all shots, he could design for a conservative square root scale distance of 70 ft/lb^{1/2}. The typical vibration levels at this scaled distance would be 0.08 to 0.15 in/sec.

4. Damage potentials for low-frequency blasts (< 40 Hz) are considerably higher than those for high-frequency blasts (> 40 Hz), with the latter often produced by close-in construction and excavation blasts.

5. Home construction is also a factor in the minimum expected damage levels. Gypsumboard (Drywall) interior walls are more damage resistant than older, plaster on wood lath construction.

6. Practical safe criteria for blasts that generate low-frequency ground vibrations are 0.75 in/sec for modern gypsumboard houses and 0.50 in/sec for plaster on lath interiors. For frequencies above 40 Hz, a safe particle velocity maximum of 2.0 in/sec is recommended for all houses.

7. All homes eventually crack because of a variety of environmental stresses, including humidity and temperature changes, settlement from consolidation and variations in ground moisture, wind, and even water absorption from tree roots. Consequently, there may be no absolute minimum vibration damage threshold when the vibration (from any cause, for instance slamming a door) could in some case precipitate a crack about to occur.

8. The chance of damage from a blast generating peak particle velocities below 0.5 in/sec is not only small (5 pct for worst cases) but decreases more rapidly than the mean prediction for the entire range of vibration levels (almost asymptotically below about 0.5 in/sec).

9. Human reactions to blasting can be the limiting factor. Vibration levels can be felt that are considerably lower than those required to produce damage. Human reaction to vibration is dependent on event duration as well as level. Particle velocities of 0.5 in/sec from typical blasting (1-sec vibration) should be tolerable to about 95 pct of the people perceiving it as "distinctly perceptible". Relevant to whole-body vibration reaction is the degree that the vibration interferes with activity (sleep, speech, TV viewing, reading), presents a health hazard, and affects task proficiency. For people at home, the most serious blast vibration problems are house rattling, fright (fear of damage or injury), being startled, and for a few, activity interference. Complaints from these causes can be as high as 30 pct at 0.5 in/sec, and this is where good public relations attitudes and an educational program by the blaster are essential.

REFERENCES

1. Ashley, C. Blasting in Urban Areas. *Tunnels and Tunneling*, v. 8, No. 6, September/October 1976, pp. 60-67.
2. Atherton, G. H., A. Polensek, and S. E. Corder. Human Response to Walking and Impact Vibration of Wood Floors. *Forest Prod. J.*, v. 26, No. 10, October 1976, pp. 40-47.
3. Beck, W. K. Fatigue Cracking of Drywall to Model Blast Loading. M.S. Thesis, Dept. Civil Eng., Northwestern Univ., Evanston, Ill., June 1979, 131 pp.
4. Bergling, J. O., K. Eklund, and C. Sjöberg. A Villa Built of Light Concrete and Concrete Exposed to Vibrations From Blasting. *Swedish Council for Bldg. Res., Bldg. Res. Summaries*, R 32, 1977, 85 pp.
5. Blume, John A. and Associates, Research Division. Response of Tall Industrial and Residential Structures to an Underground Nuclear Detonation. VELA Uniform Program, Project Dribble, Salmon Event RPT, VUF-1031. Final Rept. to the Advanced Res. Agency of the Department of Defense and the Atomic Energy Commission, Nov. 15, 1965, 31 pp.
6. Bogdanoff, I., T. Larson, and R. Nilsson. Lightweight Concrete Buildings Exposed to Vibrations From Blasting Operations. *Swedish Council for Bldg. Res., Bldg. Res. Summaries*, R 42, 1975, 47 pp.
7. Chang, F. Human Response to Motions in Tall Buildings. *Proc. ASCE*, v. 99, No. 2, June 1973, pp. 1259-1272.
8. Corser, P. Wall Cracking in Residential Structures From Surface Mining and Hard Rock Construction Blasts. M.S. Thesis, Dept. Civil Eng., Northwestern Univ., Evanston, Ill., August 1979, 199 pp.
9. Crawford, R., and H. S. Ward. Dynamic Strains in Concrete and Masonry Walls. Div. Bldg. Res., National Res. Council, Ottawa, Canada, Bldg. Res. Note 54, December 1965, 13 pp.
10. Dowding, C. H. Response of Buildings to Ground Vibrations Resulting From Construction Blasting. Ph.D. Thesis, Univ. Illinois, Urbana, Ill., 1971, 204 pp.
11. Dowding, C. H., W. K. Beck, and D. K. Atmatzidis. Blast Vibration Implications of Cyclic Shear Behavior of Model Plaster Panels. *Geotechnical Testing J.*, ASTM, v. 3, No. 2, June 1980.
12. Dowding, C. H., and P. G. Corser. Cracking and Construction Blasting. Importance of Frequency and Free Response. *J. Construction Div., ASCE*, March 1981 (in press).
13. Dowding, C. H., P. D. Murray, and D. K. Atmatzidis. Dynamic Properties of Residential Structures Subjected to Blasting Vibrations. *J. Structural Div., ASCE*, 1981 (in press).
14. Duvall, W. I., and D. E. Fogelson. Review of Criteria for Estimating Damage to Residences From Blasting Vibrations. BuMines RI 5968, 1962, 19 pp.
15. Dvorak, A. Seismic Effects of Blasting on Brick Houses. *Prace geofyrikeniha Ustance Ceskoslovenski Akademie Ved.* No. 169. *Geofysikalni Sbornik*, 1962, pp. 189-202.
16. Edwards, A. T., and T. D. Northwood. Experimental Studies of the Effects of Blasting on Structures. *The Engineer*, v. 210, Sept. 30, 1960, pp. 538-546.
17. Esteves, J. M. Control of Vibrations Caused by Blasting. *Laboratorio Nacional De Engenharia Civil*, Lisboa, Portugal, Memoria 498, 1978, 11 pp.
18. Goldman, D. E. A Review of Subjective Responses of Vibrating Motion of the Human Body in the Frequency Range, 1 to 70 Cycles per Second. *Naval Medical Res. Inst., Proj. NM 004001, Rept. 1*, Mar. 16, 1948, 17 pp.
19. International Standards Organization. Guide for the Evaluation of Human Exposure to Whole-Body Vibration. ISO 2631-1978 (E), 1978, 15 pp.
20. Jackson, M. W. Thresholds of Damage Due to Ground Motion. *Proc. Internat. Symp. on Wave Propagation and Dynamic Properties of Earth Materials*, Univ. New Mexico, Albuquerque, N. Mex., Aug. 23, 1967, pp. 961-969.
21. Jensen, D. E., and J. D. Rietman. Collection of Ground and Structure Vibration Data Generated From Small Charge Residentially Adjacent Construction Blasting. Woodward-Clyde Consultants, Proj. 410741. Final report to the Bureau of Mines, Nov. 9, 1978, 71 pp.; available for consultation at the Twin Cities Research Center, Bureau of Mines, Twin Cities, Minn.
22. Kamperman, G., and M. A. Nicholson. The Transfer Function of Quarry Blast Noise and Vibration Into Typical Residential Structures. Kamperman Associates, Inc. Final Report to the Environmental Protection Agency, Washington, D.C., EPA 550/9-77-351, February 1977, 43 pp.; National Technical Information Service, Springfield, Va., PB 288 892.
23. Koerner, R. M., J. N. Deisher, and R. P. Scheller. Laboratory Study of Cracking in Model Block Masonry Walls. *Proc. 3d Ann. Conf. on Explosives and Blasting Techniques*, Soc. Explosive Eng., Pittsburgh, Pa., Feb. 23, 1977, pp. 227-237.
24. Langan, R. T. The Use of Single-Degree-of-Freedom System as a Dynamic Model for Low-Rise Residential Structures Subjected to Blast Vibrations. M.S. Thesis, Northwestern Univ., Evanston, Ill., 1980, 79 pp.
25. Langefors, U., and B. K. Kihlstrom. *Rock Blasting*. John Wiley and Sons, Inc., New York, 1963, 405 pp.
26. Langefors, U., B. Kihlstrom, and H. Westerberg. Ground Vibrations in Blasting. *Water Power*, February 1958, pp. 335-338, 390-395, 421-424.
27. Leet, D. L. *Vibrations From Construction Blasting*. Hercules Powder Co., Wilmington, Del., 1960, 24 pp.
28. Leigh, B. R. Lifetime Concept of Plaster Panels Subjected to Sonic Boom. Univ. Toronto, Canada, UTIAS-TN-191, July 1947, 78 pp.
29. Lucole, S., and C. H. Dowding. Statistical Analysis of Blast Emission. Records From Quarrying, Mining, and Construction Operations in the State of Illinois. *Illinois Inst. of Nat. Res., Doc. 79/02, Proj. 30.013*, January 1979, 200 pp.
30. Medearis, K. The Development of Rational Damage Criteria for Low-Rise Structures Subjected to Blasting Vibrations. Kenneth Medearis Associates, Final Rept. to National Crushed Stone Assn., Washington, D.C., August 1976, 93 pp.
31. Morris, G., and R. Westwater. Damage to Structures by Ground Vibrations Due to Blasting. *Mine and Quarry Eng.*, April 1953, pp. 116-118.
32. Murray, P. D. Dynamic Properties of Residential Structures Subjected to Blasting Vibrations. M.S. Thesis, Dept. Civil Eng., Northwestern Univ., Evanston, Ill., June 1978, 142 pp.

33. Murray, T. M. Acceptability Criteria for Occupant-Induced Floor Vibrations. *Sound and Vibration*, v. 13, No. 11, November 1979, pp. 24-30.
34. Nadolski, M. E. Architectural Damage to Residential Structures From Seismic Disturbances. *Bull. Seis. Soc. Am.*, v. 59, No. 2, April 1969, pp. 487-502.
35. Navarro, R. Old Reliable Mine Project Seismic Measurements. NOAA Tech. Memo, ERL ESL-19, July 1972, 17 pp.
36. Nelson, W. H. Movement of Building Element Cracks in Six Mercury Nevada Structures. John A. Blume and Associates, Research Div., San Francisco, Rept. NVO-99-20 to The Nevada Operations Office. U.S. Atomic Energy Comm., December 1957, 45 pp. (contract AT (26-1)-99).
37. Nicholls, H. R., C. F. Johnson, and W. I. Duvall. Blasting Vibrations and Their Effects on Structures. *BuMines Bull.* 656, 1971, 105 pp.
38. Northwood, T. D., R. Crawford, and A. T. Edwards. Blasting Vibrations and Building Damage. *The Engineer*, v. 215, No. 5601, May 31, 1963, pp. 973-978.
39. Power, D. V. A Survey of Complaints of Seismic Related Damage to Surface Structures—Salmon Event. *Bull. Seis. Soc. Am.*, v. 56, No. 6, December 1966, pp. 1413-1428.
40. Reiher, H., and F. J. Meister. (The Effect of Vibration on People.) *Forschung auf dem Gebiete des Ingenieurwesens (Germany)*, v. 2, No. 11, 1931, p. 381; transl. by Headquarters Air Material Command, Wright Field, Ohio, Rept. F-TSL-616-RE, 1946.
41. Richter, C. F. *Elementary Seismology*. W. H. Freeman and Co., San Francisco, 1958, 768 pp.
42. Scholl, R. E. Low-Rise Building Damage From Low Amplitude Ground Motions. John A. Blume and Associates, Research Div., San Francisco, Rept. JAB-99-117 to U.S. Atomic Energy Comm., April 1974, 22 pp. (contact AT(26-1)-99).
43. Scholl, R. E., and I. Farhoomand. Statistical Correlation of Observed Ground Motion With Low-Rise Building Damage. *Bull. Seis. Soc. Am.*, v. 63, No. 5, October, 1973, pp. 1515-1537.
44. Seismore, C. J. Analyzing of Surface-Motion Data From Old Reliable Mine Blast. Lawrence Livermore Lab., Rept. UDIC-16314, July 19, 1973, 19 pp.
45. Siskind, D. E., V. J. Stachura, and K. S. Radcliffe. Noise and Vibrations in Residential Structures From Quarry Production Blasting. Measurements at Six Sites in Illinois. *BuMines RI* 8168, 1976, 17 pp.
46. Siskind, D. E., V. J. Stachura, M. S. Stagg, and J. W. Kopp. Structure Response and Damage Produced by Airblast From Surface Mining. *BuMines RI* 8485, 1980.
47. Skipp, B. O. Ground Vibration Instrumentation—A General Review. *Instrumentation for Ground Vibration and Earthquakes. Proc., Conf. for Earthquake and Civil Eng. Dynamics*, Keele, England, July 4, 1977, pp. 11-34.
48. Snodgrass, J. J., and D. E. Siskind. Vibrations From Underground Blasting. *BuMines RI* 7937, 1974, 31 pp.
49. Stachura, V. J., D. E. Siskind, and A. J. Engler. Airblast Instrumentation and Measurement Techniques for Surface Mine Blasting. *BuMines RI* 8508, 1981 (in press).
50. Stagg, M. S., and A. J. Engler. Ground Vibration Measurement and Seismograph Calibration. *BuMines RI* 8506, 1980 (in press).
51. Thoenen, J. R., and S. L. Windes. Seismic Effects of Quarry Blasting. *BuMines Bull.* 442, 1942, 83 pp.
52. Tynan, A. E. Ground Vibrations, Damaging Effects to Buildings. *Australian Road Res. Bd.*, Spec. Rept. 11, 1973, 61 pp.
53. Wall, J. F., Jr. Seismic-Induced Architectural Damage to Masonry Structures at Mercury, Nevada. *Bull. Seis. Soc. Am.*, v. 57, No. 5, October 1967, pp. 991-1007.
54. Wendler, B. H., M. J. Rosenfield, J. B. Gambill, W. E. Fischer, R. G. Merritt, and J. A. Gill. Shock Environment Test of Model Drywall Room (Bureau of Mines Test Package No. 1). U.S. Army Constr. Eng. Res. Lab., Champaign, Ill., Tech. Rept. M-152, August 1975, 81 pp.
55. Whiffin, A. C., and D. R. Leonard. A Survey of Traffic-Induced Vibrations. *Road Res. Lab.*, Dept. Environment, Crowthorne, Berkshire, England, Rept. RRL LR 418, 1971, 58 pp.
56. Wiss, J. F., and P. Linehan (Wiss, Janney, Elstner and Associates, Inc.). Control of Vibration and Blast Noise From Surface Coal Mining. *BuMines Open File Rept.* 79-103, 1979, v. 1, 159 pp.; v. 2, 280 pp.; v. 3, 624 pp.; v. 4, 48 pp.; available for consultation at the BuMines libraries in Denver, Colo., Twin Cities, Minn., Pittsburgh, Pa., and Spokane, Wash.; U.S. Dept. Energy facilities in Carbondale, Ill., and Morgantown, W. Va.; Nat. Mine Health and Safety Academy, Beckley, W. Va.; and Nat. Library of Natural Resources, U.S. Dept. Interior, Washington, D.C. Contract JO 255022; Nat. Tech. Inf. Service, Springfield, Va., PB 299 886/AS.
57. Wiss, J. F., and H. R. Nicholls. A Study of Damage to a Residential Structure From Blast Vibrations. *Res. Council for Performance of Structures, ASCE*, New York, 1974, 73 pp.
58. Wiss, J. F., and R. A. Parmelee. Human Perception of Transient Vibrations. *J. Structural Div., ASCE*, v. 100, No. ST4, Proc. Paper 10495, April 1974, pp. 773-787.

APPENDIX A.—EXISTING VIBRATION STANDARDS AND CRITERIA TO PREVENT DAMAGE

The German vibration standards (DIN 4150) are intended to protect buildings but are so strict as to be unworkable (table A-1). Reportedly, they are not enforced, at least for blasting. No technical data have been given to justify the levels specified (4, 52).¹

The Australian standard (CA 23-1967) specifies maximums of

- (1) 0.008-in displacement for frequencies less than 15 Hz and
- (2) 0.75 in/sec resultant peak particle velocity for frequencies greater than 15 Hz.

The 0.008-in maximum displacement corresponds to 0.5 in/sec at 10 Hz and 0.25 in/sec at 5 Hz.

Skipp (47) lists a variety of national vibration limits, including the Czechoslovakian maximum code of 10 mm/sec (0.40 in/sec). Skipp states, "in countries without formal codes, good practice usually takes into account the intrusive element without specifying a particular damage state. In the U. K. for example for tunnel blasting, 10 mm/sec has been the aim in densely populated areas and 25 mm/sec in sparsely popu-

Table A-1.—German vibration standards, DIN 4150

Type of construction	Peak pseudo vector sum particle velocity	
	mm/sec	in/sec
Ruins, ancient and historic buildings given antiquities protection	2	0.08
Buildings with visible damage and cracks in masonry	4	.16
Buildings in good condition, possibly with cracks in plaster	8	.32
Industrial and concrete structures without plaster	10-40	.39-1.56

lated areas." The British Secretary of State specified that 12 mm/sec (0.47 in/sec) be used for surface coal mine blasts that generate frequencies below 12 Hz.

Bogdanoff's damage paper (6) summarizes safe values from the text "Rock Blasting," by Langefors and Kihlstrom (25), given in table A-2. The propagation velocity (c) is related to particle velocity (V) and ground strain (e) according to:

$$e = \frac{V}{c}$$

¹ Italic numbers in parentheses refer to items in the list of references preceding the appendixes.

Table A-2.—Damage levels from blasting, after Langefors and Kihlstrom (25)

Damage effects	Peak particle velocity					
	Sand, gravel, clay below water level: c = 1,000 - 1,500 m/sec ¹		Moraine, slate, or soft limestone: c = 2,000 - 3,000 m/sec		Granite, hard limestone, or diabase: c = 4,500 - 6,000 m/sec	
	mm/sec	in/sec	mm/sec	in/sec	mm/sec	in/sec
No noticeable crack formation	18	0.71	35	1.4	70	2.8
Fine cracks and falling plaster threshold	30	1.2	55	2.2	100	3.9 4.13
Crack formation	40	1.6	80	3.2	130 160	5.1 6.3
Severe cracks	60	2.4	115	4.5	225 230	8.8 9.1

¹ Propagation velocity in media is given by c.

Table A-3.—Limiting safe vibration values of pseudo vector sum peak particle velocities, after Esteves (17)

Type of construction	Peak particle velocity					
	Incoherent loose soils, soft coherent soils, rubble mixtures: c < 1,000 m/sec ¹ c < 3,300 ft/sec ¹		Very hard to medium consistence coherent soils, uniform or well-graded sand: c = 1,000-2,000 m/sec c = 3,300-6,600 ft/sec		Coherent hard soils and rock: c > 2,000 m/sec c > 6,600 ft/sec	
	mm/sec	in/sec	mm/sec	in/sec	mm/sec	in/sec
Special care, historical monuments, hospitals, and very tall buildings	2.5	0.10	5	0.20	10	0.40
Current construction	5	.20	10	.40	20	.80
Reinforced construction, e.g., earthquake resistant	15	.60	30	1.20	60	2.40

¹ Propagation velocity in media given by c.

Consequently, low-velocity materials will have higher ground strains (and potentials for failure) for a given particle velocity. Langefors and Kihlstrom did not give the experimental data to support their thresholds of table A-2. Esteves' study (17) includes safe values for a variety of conditions, including types of soil, construction, and frequency of blasting (table A-3). As with Langefors and Kihlstrom (table A-2), Esteves does not give the supporting experimental data. Ashley lists maximum particle velocities for a variety of structure types (1). Again, technical data to derive or support the recommended values are not given (table A-4).

Several survey papers have been written that combined nuclear blast, earthquake, and blasting data without pointing to the variations among vibration characteristics and the resulting response and damage potentials (20, 34). The worst-case experimental data are from the Salmon nuclear blast and the Mercury, Nev., studies. These results are overly conservative for blasting, and their use cannot be justified on technical grounds.

Cases occasionally arise where blasting vibration is considered a potential problem to equipment, or concern is expressed about the vibration sources such as traffic. The safe level criteria established for blasting are often applied to these situations with little justification. Traffic is usually a steady-state source of low amplitude.

Appropriate safe levels would have to be lower than for blasting, which is relatively infrequent and of shorter duration. The British criterion for architectural damage from steady-state sources is 5 mm/sec (0.20 in/sec) (55). Vibration standards for laboratory instruments are given in table A-5.

Table A-4.—Limiting safe vibration values, after Ashley (1)

Type of construction	Peak particle velocity	
	mm/sec	in/sec
Ancient and historic monuments	7.5	0.30
Housing in poor repair	12	.47
Good residential, commercial, and industrial structures	25	1.0
Welded gas mains, sound sewers, engineered structures	50	2.0

Table A-5.—Vibration limits for laboratory instruments, after Whiffin and Leonard (55)

Dimensional and electrical physical reference standards	g ¹	0.01
Do	in/sec	² 0.031
Dimensional working standards	g	0.02
Do	in/sec	² 0.062
Electrical, physical working standards	g	0.03
Do	in/sec	² 0.093
General electronic apparatus	in/sec	0.19
Mettler analytical balance	in/sec	² 0.0125
Sartorius analytical balance	in/sec	² 0.10
Leeds—Northrup Reflection Galvanometer	in/sec	² 0.0125
Photo microscope	in/sec	1.44
Phillips EM 300 electron microscope	in/sec	0.00013
HAA S standards barometer	in/sec	0.08

¹ g = acceleration of gravity 9.8 m/sec² (32.2 ft/sec²).

² At 20 Hz.

APPENDIX B.—ALTERNATIVE BLASTING LEVEL CRITERIA

Safe blasting vibration criteria were developed for residential structures, having two frequency ranges and a sharp discontinuity at 40 Hz (table 13). There are blasts that represent an intermediate frequency case, being higher than the structure resonances (4 to 12 Hz) and lower than 40 Hz. The criteria of table 13 apply equally to a 35-Hz and a 10-Hz ground vibration, although

the responses and damage potentials are very much different.

Using both the measured structure amplifications (fig. 39) and damage summaries (figs. 52 and 54), a smoother set of criteria was developed. These criteria have more severe measuring requirements, involving both displacement and velocity (fig. B-1).

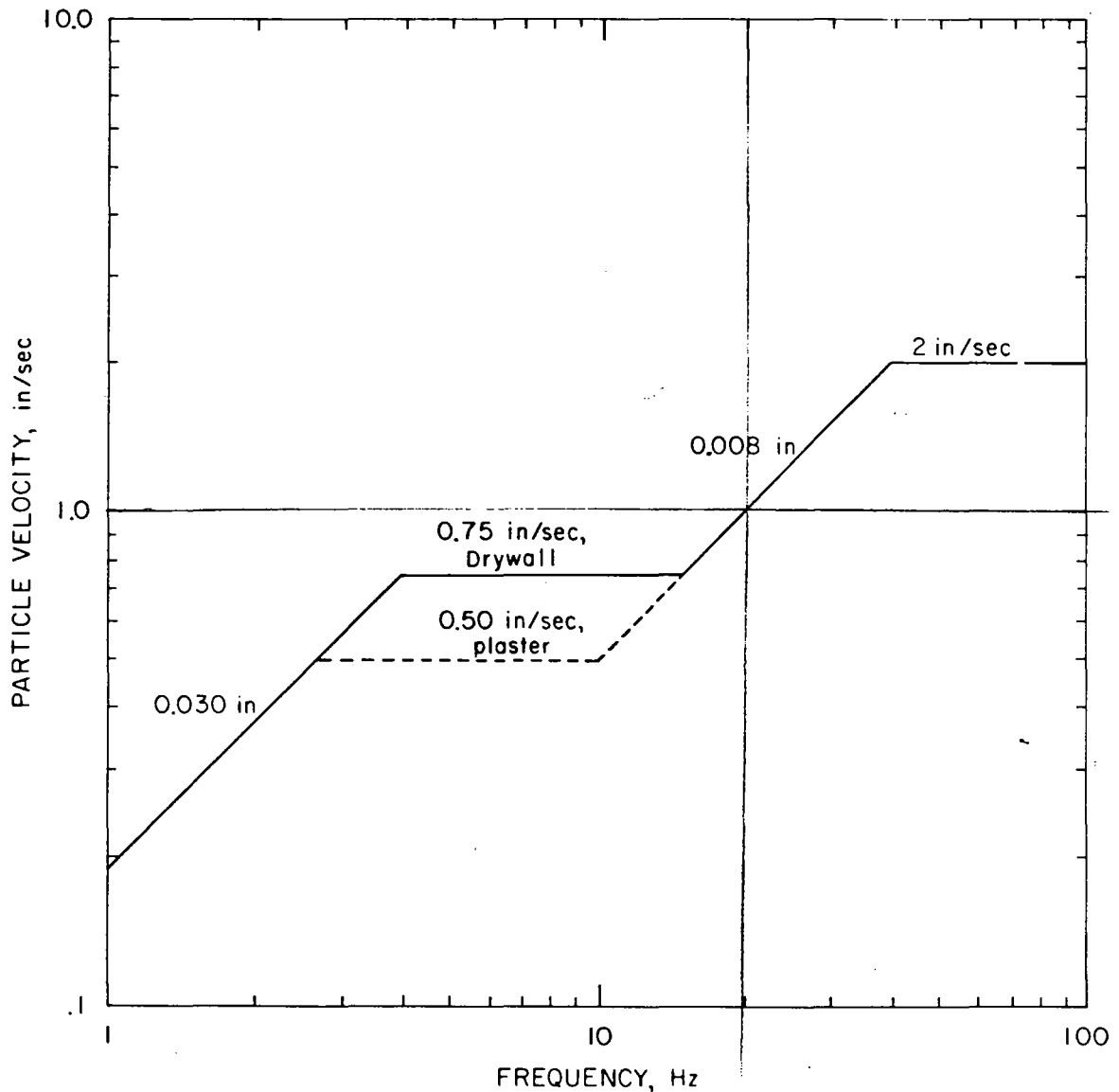

Figure B-1.—Safe levels of blasting vibration for houses using a combination of velocity and displacement.

Above 40 Hz, a constant peak particle velocity of 2.0 in/sec is the maximum safe value. Below 40 Hz, the maximum velocity decreases at a rate equivalent to a constant peak displacement of 0.008 in. At frequencies corresponding to 0.75 in/sec for Drywall, and 0.50 in/sec for plaster, constant particle velocities are again appropriate. An ultimate maximum displacement of 0.030 in is recommended, which would only be of concern where very low frequencies are encountered (< 4 Hz).

This scheme is based on the response and damage data, recognizes the displacement-bound requirement for house responses to blast vibra-

tions, and provides a smooth transition for the intermediate frequency cases. This method of analyzing the damage potential of blasting vibrations has the disadvantage of possibly underestimating annoyance reactions. Midwall responses (fig. 40) do not decrease nearly as fast as structure (corner) responses as frequencies increase from 10 to 40 Hz. A very nearly linear decrease of velocity amplification was observed for the gross structure; however, the higher midwall response frequencies will make the 20- to 35-Hz vibrations relatively annoying if the maximum levels shown on figure B-1 are attained.

STRUCTURE RESPONSE AND DAMAGE
PRODUCED BY GROUND VIBRATION
FROM SURFACE MINE BLASTING

by

David E. Siskind, Mark S. Stagg,
John W. Kopp, and Charles H. Dowding

ERRATA

- Page 1, line 14 should read "Safe levels" instead of "Save levels."
- Page 3, footnote should read "Italic numbers" instead of "Underlined numbers."
- Page 12 (table 1): Seven shots that were omitted are given on the attached page. In addition, for shot 134 "Peak ground vibration (H_2)" should be 0.32 instead of 0.36, and the column heading labeled "Sealed distance" should read "Scaled distance."
- Page 19 (equation 2): Sign before $\frac{\beta}{\sqrt{1 - \beta^2}}$ should be minus instead of plus.
- Page 23 (table 3): Structures numbered 58 and above have some of the shots improperly indicated. The attached table shows the correct values, and is consistent with table 1.
- Page 28, caption of figure 28 should be "Test structure 61, near a construction site."
- Page 41 (table 5): Footnote 4 should show 119 dB airblast instead of 111 dB.
- Page 42 (table 6): Values in "Mine blasts" column should read 0.377 instead of 0.472 and .314 instead of .392. Footnote 1 should have 119 dB airblast instead of 111 dB.
- Page 48 (table 9): Jensen and Rietman reference number should be 21 instead of 57. Also, under "Damage observed, uniform classification," Nondamage and Threshold values for "Bureau of Mines new data" should be 76 and 28, respectively, not 37 and 23.
- Page 71 (table A-2): Values in the "Granite, hard limestone, or diabase" column should be as follows:

mm/sec	in/sec
70	2.8
110	4.3
160	6.3
230	9.1



CORRECTIONS FOR TABLE 3 OF RI 8507

Test structures and measured dynamic properties

Structure	Shots (table 1)
57	201,202
58	203-209
59	W-1
60	W-2, W-3
61	W-4, W-5
62	W-6
63	W-7, W-8
64	W-9, W-10
65	W-11, W-12
66	W-13, W-14, W-15
67	W-16, W-17
68	W-18, W-19
69	W-20, W-21
70	W-22
71	W-23
72	W-24
73	W-25, W-26, W-27
74	W-28, W-29
75	W-30
76	W-31, W-32

